

# 670G LC/870G LC

67–87 metric ton



JOHN DEERE



# Expect big things.

When the task demands a serious excavator to get it done, get a John Deere G-Series. With more hydraulic flow than their highly productive predecessors, our 670G LC and 870G LC deliver faster work cycles to move more material on a gallon of fuel. Their rugged Interim Tier 4/EU Stage IIIB diesels enable you to work, wherever there's work, even in nonattainment areas. Numerous customer-inspired refinements include a more comfortable and spacious cab. And an enhanced LCD monitor with simplified navigation that lets an operator easily dial-in a wealth of machine information and functionality. If you're looking to amass more productivity, our G-Series Excavators are a great place to start.

## 670G LC

<b>Net rated power</b>	345 kW (463 hp)
<b>Operating weight</b>	71 688 kg (158,045 lb.)
<b>Lifting capacity</b>	15 300 kg (32,900 lb.)
<b>Maximum digging depth</b>	9.15 m (30 ft. 0 in.)
<b>Arm digging force</b>	224–231 kN (50,357–51,931 lb.)
<b>Bucket digging force</b>	290–324 kN (65,195–72,838 lb.)

## 870G LC

397 kW (532 hp)
87 659 kg (193,255 lb.)
20 260 kg (43,800 lb.)
9.57 m (31 ft. 5 in.)
273–280 kN (61,373–62,946 lb.)
359–399 kN (80,706–89,699 lb.)



The IT4/Stage IIIB technology utilized in our diesel engines is simple, fuel efficient, fully integrated, and fully supported.

Hydraulically driven, highly efficient fan runs only as needed, reducing noise, fuel consumption, and operating costs. Standard operator-selectable reversing option automatically back-blows cooler cores to keep them clean.

With a larger entryway, more legroom, and standard air-suspension heated seat, the G-Series' refined cab delivers even more convenience and comfort.

Extended engine and hydraulic oil-service intervals increase uptime and reduce daily operating costs.



670G LC and 870G LC are standard equipped with JDLink™ Ultimate, giving you 24/7 online access to your excavator. Track machine health, utilization, and fuel consumption — valuable information that helps you better understand costs and jobsite performance. Plus, you can help protect your equipment from unauthorized movement by setting up geofence and curfew alerts in your JDLink account.

Powerwise III perfectly balances engine performance and hydraulic flow for predictable operation. Three productivity modes allow you to choose the digging style that fits the job. **High-productivity** delivers more power and faster hydraulic response to move more material. **Power** delivers a balance of power and speed for normal operation. **Economy** limits top speed and helps save fuel.

Choose from a variety of track widths, arm lengths, buckets, and other options.

## Smart choice.

Make no mistake, our G-Series Excavators deliver plenty of productive punch. But the 670G LC and 870G LC aren't all brawn and no brains. Smart features like our Powerwise™ III engine/hydraulic management system with multiple productivity modes enable you to put that extra ability to use with the same kind of smooth precision that operators have come to expect from our excavators. What's more, advantages such as our JDLink Ultimate machine monitoring system and Service ADVISOR™ diagnostics help keep you informed about machine utilization and maintenance. Who says you have to choose between working harder or smarter?



1. For work that requires extra finesse, short-throw low-effort controls, unmatched metering, and smooth multifunction operation give you the precision you need.

2. Their exceptional swing torque, lift capacity, and arm and bucket digging force provide generous muscle for mass excavating or hot truck loading.

3. When conditions call for a little extra, simply press the power-boost button on the right-hand control and muscle through.



# Here's a new twist on operating ease.

Now it's easier than ever for your operators to "dial things up." The G-Series' refined monitor employs a turn-and-tap rotary control that provides quick access to an abundance of performance and convenience features and functions. Operators will also appreciate the standard air-suspension high-back heated seat and increased legroom in the spacious, well-appointed cab. As always, unsurpassed all-round visibility, low-effort joysticks, a highly efficient HVAC system, and numerous other amenities provide all your operators need to tap into their abilities. And push productivity to the max.

With large self-cleaning steps, convenient handholds, and wide entryways, getting to "the office" has never been easier.

Spacious cab is comfortable and noticeably quiet. Silicone-filled mounts effectively isolate operators from noise and vibration.

We've got your back. Standard equipment includes a multi-position air-suspension heated seat. With 267 mm (10½ in.) of travel, sliding together or independent of the joystick console, there's plenty of legroom so it won't cramp an operator's style.

Ergonomically correct short-throw pilot levers provide smooth, predictable fingertip control.

No shortage of storage in here. There's a place for a cooler, cup holders, and even a hot/cold box that keeps food or beverages at just the right temperature.

Lights on the cab and both sides of the boom illuminate the way for work that begins or extends beyond daylight.

1. Multi-language LCD monitor and rotary dial provide intuitive access to a wealth of information and functions. Just turn and tap to select work mode, access operating info, check maintenance intervals, source diagnostic codes, adjust cab temperature, and tune the radio. Plus much more.
2. Wide expanse of front and side glass, narrow front cab posts, large overhead glass, and numerous mirrors provide virtually unobstructed all-around visibility. A rear-mount camera displays the activity behind you on the monitor in front of you.
3. Automatic, high-velocity bi-level climate-control system with automotive-style adjustable louvers helps keep the glass clear and the cab comfortable.



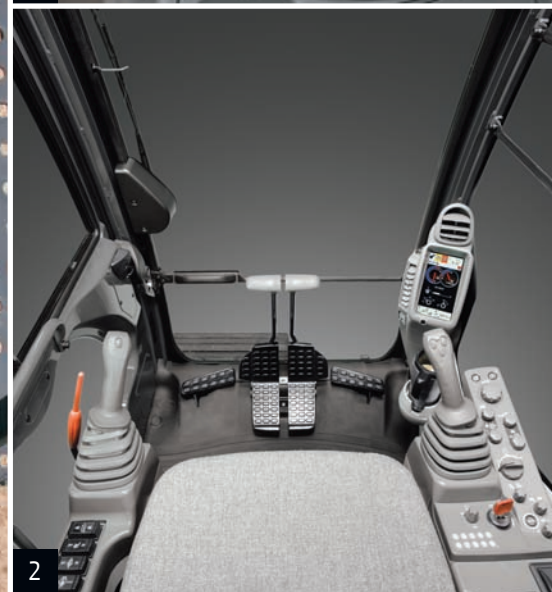

# Nothing runs like a Deere, because nothing is built like one.

Chances are, you've got plenty of people, equipment, and other resources relying on your excavators. And you can depend on our G-Series to deliver. Both 670G LC and 870G LC employ many of the same job-proven digging structures and hydraulic, electrical, and undercarriage components as their highly regarded D-Series predecessors. You'll also continue to profit from durability-enhancing "extras" such as welded boom bulkheads, reinforced D-channel side frames, heavy-duty cooling systems, and extended service intervals. When you know how they're built, you'll run a Deere.

Our IT4/Stage IIIB technology is simple, fuel efficient, fully integrated, and fully supported. It employs field-proven cooled exhaust gas recirculation (EGR) for reducing NO<sub>x</sub>, and a diesel particulate filter and a diesel oxidation catalyst to reduce particulate matter. Periodic active and passive regeneration automatically cleans the filter without impacting machine productivity.

A John Deere exclusive, three welded bulkheads within the boom resist torsional stress for unsurpassed durability. In fact, boom, arm, and mainframe are so tough, they're warranted for three years or 10,000 hours.

1. Thick-plate single-sheet mainframe, box-section track frames, and industry-exclusive double-seal swing bearings deliver rock-solid durability.

2. Rigid, reinforced D-channel side frames provide maximum cab and component protection.

3. With strutted links and large idlers and rollers, the sealed and lubricated heavy-duty undercarriage delivers long and reliable performance.

4. Highly efficient, heavy-duty cooling system keeps things cool, even in tough environments or high altitudes.





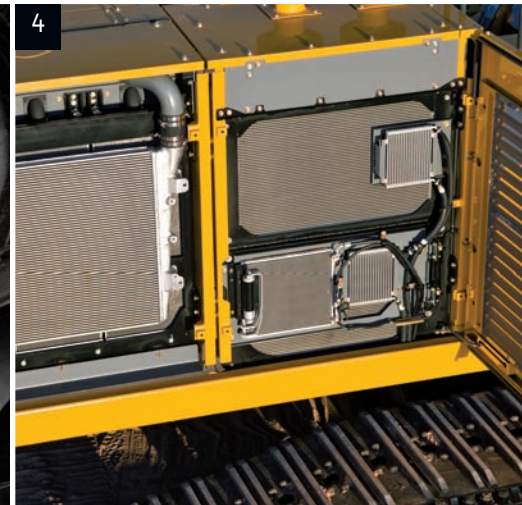
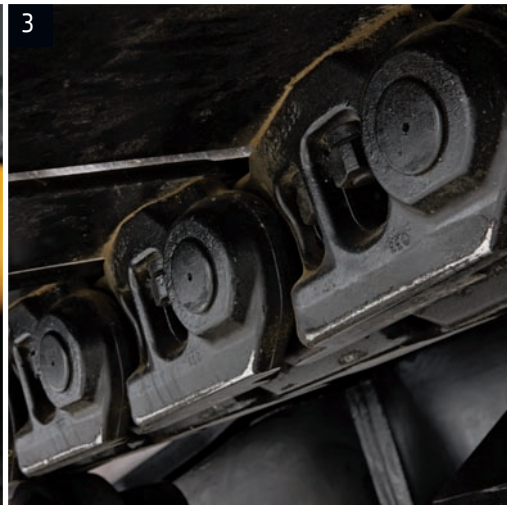

# You'll become a big fan of the G-Series.

Swing open the service panels and engine covers, and you'll discover many of the numerous ways we minimize maintenance, increase uptime, and reduce daily operating costs. Take the G-Series' heavy-duty cooling systems, for example. Their hydraulically driven fans run only as fast or often as needed, reducing fuel consumption and wear-causing debris flow through the cooler cores. As always, grouped service points make quick work of the daily routine. Plus, easy-to-check sight gauges and fluid reservoirs, quick-change remote-mounted filters, and advanced self-diagnostics all help ensure that maintenance is no big deal.

Wide, slip-resistant steps and "Deere-walk," sturdy handrails, and large easy-to-open service doors provide convenient access to grouped service points and major components.

Auto-idle automatically reduces engine speed when hydraulics aren't in use. Auto shutdown further preserves precious fuel.

Diesel particulate filter is easily removed through the top of the engine compartment. Minimum service interval is 4,500 hours, and can be done by your John Deere dealer.

Advanced self-diagnostics help you make timely decisions about machine upkeep.

Large fuel tanks and 500- and 4,000-hour engine and hydraulic oil-service intervals decrease downtime for routine maintenance.

Centralized lube banks place difficult-to-lube zerks within easy reach. Convenient color-coded chart helps ensure that nothing gets overlooked.



Engine Oil Filter	
Previous Maintenance	
2011/07/04	0.0 h
Remains	375.8 h
Maintenance Interval	500.0 h



1. Vertical spin-on fuel filters and hydraulic and engine oil filters simplify service and help minimize messes. Filters and checkpoints are conveniently grouped.
2. Fresh-air cab filter can be quickly serviced from outside the cab. Where it's more likely to get done.
3. Easy-to-navigate LCD monitor issues scheduled maintenance alerts. Should a problem arise, it provides diagnostic info and offers possible solutions to decrease downtime.
4. Their unique Turn-Kam retainer enables TK-Series bucket teeth to be installed or removed with a simple half-turn of a wrench. The hammerless system is standard on John Deere buckets.
5. Coolers are well-protected behind heavy-duty hinged doors, yet readily accessible. Swing-out coolers further simply clean-out.
6. Standard reversing fan back-blows cooler cores to reduce debris buildup and help increase uptime.



4



5



6

# 670G LC

<b>Engine</b>	<b>670G LC</b>		
Manufacturer and Model	Isuzu 6WG1-iT4		
Non-Road Emissions Standard	EPA Interim Tier 4/EU Stage IIIB		
Net Rated Power (ISO 9249)	345 kW (463 hp) at 1,800 rpm		
Cylinders	6		
Displacement	15.7 L (957 cu. in.)		
Off-Level Capacity	70% (35 deg.)		
Aspiration	Turbocharged, air-to-air charge-air cooler		
<b>Cooling</b>	2 cool-on-demand hydraulic-driven, suction-type fans with remote-mounted drives		
<b>Powertrain</b>	2-speed propel with Autoshift		
<b>Maximum Travel Speed</b>			
Low	3.6 km/h (2.2 mph)		
High	5.2 km/h (3.2 mph)		
Drawbar Pull	46 115 kg (101,666 lb.)		
<b>Hydraulics</b>	Open center, load sensing		
<b>Main Pumps</b>	2 variable-displacement pumps		
Maximum Rated Flow	489 L/m (129 gpm) x 2		
<b>Pilot Pump</b>	One gear		
Maximum Rated Flow	30 L/m (7.9 gpm)		
Pressure Setting	3900 kPa (566 psi)		
<b>System Operating Pressure</b>			
Circuits			
Implement	31 900 kPa (4,627 psi)		
Travel	34 300 kPa (4,975 psi)		
Swing	29 400 kPa (4,264 psi)		
Power Boost	34 300 kPa (4,975 psi)		
<b>Controls</b>	Pilot levers, short stroke, low-effort hydraulic pilot controls with shutoff lever		
<b>Cylinders</b>	Heat-treated, chrome-plated, polished cylinder rods; hardened steel (replaceable bushings) pivot pins		
	<i>Bore</i>	<i>Rod Diameter</i>	<i>Stroke</i>
<b>Boom (2)</b>	191 mm (7.5 in.)	130 mm (5.1 in.)	1806 mm (71 in.)
<b>Arm (1)</b>	201 mm (7.9 in.)	140 mm (5.5 in.)	2164 mm (85 in.)
<b>Bucket (1)</b>	180 mm (7.1 in.)	130 mm (5.1 in.)	1555 mm (61 in.)
<b>Electrical</b>			
Number of Batteries (12 volt)	2		
Battery Capacity	500 CCA		
Alternator Rating	50 amp		
Work Lights	5 halogen (one mounted on frame, 2 mounted on boom, and 2 mounted on top of cab)		
<b>Undercarriage</b>			
<b>Rollers (each side)</b>			
Carrier	3		
Track	8		
Shoes, Double-Bar Grousers (each side)	47		
<b>Track</b>			
Adjustment	Hydraulic		
Guides	Front and center		
Chain	Sealed and lubricated		
<b>Ground Pressure</b>			
Double-Bar Grouser Shoes			
650 mm (26 in.)	93.8 kPa (13.6 psi)		
750 mm (30 in.)	82.7 kPa (12.0 psi)		
900 mm (36 in.)	69.6 kPa (10.1 psi)		



**Swing Mechanism 670G LC**

Speed	9.1 rpm
Torque	194 000 Nm (143,087 lb.-ft.)

**Serviceability**

**Refill Capacities**

Fuel Tank	900 L (238 gal.)
Cooling System	70 L (18.5 gal.)
Engine Oil with Filter	57 L (15.1 gal.)
Hydraulic Tank	380 L (100.4 gal.)
Hydraulic System	750 L (198.1 gal.)
Gearbox	
Swing (each)	10.5 L (11.1 qt.)
Travel (each)	16 L (16.9 qt.)
Pump Drive	6.2 L (6.6 qt.)

**Operating Weights**

With full fuel tank; 79-kg (175 lb.) operator; 3.09-m<sup>3</sup> (4.04 cu. yd.), 1370-mm (54 in.), 3126-kg (6,892 lb.) bucket; 4.2-m (13 ft. 9 in.) arm; 10 400-kg (22,928 lb.) counterweight; and 900-mm (36 in.) double-bar grouser shoes

SAE Operating Weight	71 688 kg (158,045 lb.)
----------------------	-------------------------

**Component Weights**

**Undercarriage with Double-Bar Grouser Shoes**

650 mm (26 in.)	26 620 kg (58,687 lb.)
750 mm (30 in.)	27 240 kg (60,054 lb.)
900 mm (36 in.)	28 180 kg (62,126 lb.)

**One-Piece Boom (with arm cylinder)**

7.8 m (25 ft. 7 in.)	6550 kg (14,440 lb.)
6.8-m (22 ft. 4 in.) Mass Excavating	6110 kg (13,470 lb.)

**Arm with Bucket Cylinder and Linkage**

3.6 m (11 ft. 10 in.)	3620 kg (7,981 lb.)
4.2 m (13 ft. 9 in.)	3930 kg (8,664 lb.)
5.3 m (17 ft. 5 in.)	3620 kg (7,981 lb.)
2.9-m (9 ft. 6 in.) Mass Excavating	3820 kg (8,422 lb.)

**Boom-Lift Cylinders (2), Total Weight**

3.09-m <sup>3</sup> (4.04 cu. yd.), 1370-mm (54 in.)	3126 kg (6,892 lb.)
--	---------------------

**Heavy-Duty High-Capacity Bucket**

Counterweight, Standard	10 400 kg (22,928 lb.)
-------------------------	------------------------

**Operating Dimensions**

<b>Arm Length</b>	3.6 m (11 ft. 10 in.) w/ 7.8-m (25 ft. 7 in.) Boom	4.2 m (13 ft. 9 in.) w/ 7.8-m (25 ft. 7 in.) Boom	5.3 m (17 ft. 5 in.) w/ 7.8-m (25 ft. 7 in.) Boom	2.9-m (9 ft. 6 in.) Mass Excavating w/ 6.8-m (22 ft. 4 in.) Mass-Excavating Boom
-------------------	--	---	---	--

<b>Arm Digging Force</b>				
SAE	247 kN (55,528 lb.)	224 kN (50,357 lb.)	192 kN (43,163 lb.)	297 kN (66,768 lb.)
ISO	255 kN (57,326 lb.)	231 kN (51,931 lb.)	196 kN (44,063 lb.)	306 kN (68,792 lb.)

<b>Bucket Digging Force</b>				
SAE	290 kN (65,195 lb.)	290 kN (65,195 lb.)	245 kN (55,078 lb.)	332 kN (74,637 lb.)
ISO	324 kN (72,838 lb.)	324 kN (72,838 lb.)	277 kN (62,272 lb.)	369 kN (82,954 lb.)

<b>Lifting Capacity Over Front at Ground Level</b>				
9.0-m (30 ft.) Reach (with power boost)	15 211 kg (32,695 lb.)	15 300 kg (32,900 lb.)	15 522 kg (33,628 lb.)	15 190 kg (32,649 lb.)

<b>A</b>	Maximum Reach	13.25 m (43 ft. 6 in.)	13.85 m (45 ft. 5 in.)	14.74 m (48 ft. 4 in.)	11.81 m (38 ft. 9 in.)
<b>A'</b>	Maximum Reach at Ground Level	13.00 m (42 ft. 8 in.)	13.61 m (44 ft. 8 in.)	14.51 m (47 ft. 7 in.)	11.50 m (37 ft. 9 in.)
<b>B</b>	Maximum Digging Depth	8.53 m (28 ft. 0 in.)	9.15 m (30 ft. 0 in.)	10.03 m (32 ft. 11 in.)	7.12 m (23 ft. 4 in.)

<b>B'</b>	Maximum Digging Depth at 2.44-m (8 ft. 0 in.) Flat Bottom	8.40 m (27 ft. 7 in.)	9.03 m (29 ft. 8 in.)	9.92 m (32 ft. 7 in.)	6.97 m (22 ft. 10 in.)
-----------	---	-----------------------	-----------------------	-----------------------	------------------------

<b>C</b>	Maximum Cutting Height	11.92 m (39 ft. 1 in.)	12.24 m (40 ft. 2 in.)	12.65 m (41 ft. 6 in.)	11.90 m (39 ft. 1 in.)
----------	------------------------	------------------------	------------------------	------------------------	------------------------

<b>D</b>	Maximum Dumping Height	8.05 m (26 ft. 5 in.)	8.33 m (27 ft. 4 in.)	9.17 m (30 ft. 1 in.)	7.33 m (24 ft. 1 in.)
----------	------------------------	-----------------------	-----------------------	-----------------------	-----------------------

<b>E</b>	Minimum Swing Radius	5.78 m (19 ft. 0 in.)	5.76 m (18 ft. 11 in.)	5.60 m (18 ft. 4 in.)	5.24 m (17 ft. 2 in.)
----------	----------------------	-----------------------	------------------------	-----------------------	-----------------------

<b>F</b>	Maximum Vertical Wall	7.38 m (24 ft. 3 in.)	8.18 m (26 ft. 10 in.)	9.53 m (31 ft. 3 in.)	5.28 m (17 ft. 4 in.)
----------	-----------------------	-----------------------	------------------------	-----------------------	-----------------------

<b>G</b>	Tail-Swing Radius	4.02 m (13 ft. 2 in.)	4.02 m (13 ft. 2 in.)	4.02 m (13 ft. 2 in.)	4.02 m (13 ft. 2 in.)
----------	-------------------	-----------------------	-----------------------	-----------------------	-----------------------

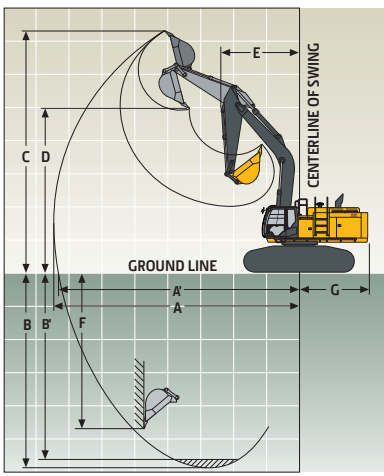

**Machine Dimensions 670G LC**

<b>A</b> Overall Length with Arm	
3.6 m (11 ft. 10 in.)	13.40 m (44 ft. 0 in.)
4.2 m (13 ft. 9 in.)	13.40 m (44 ft. 0 in.)
5.3 m (17 ft. 5 in.)	13.06 m (42 ft. 10 in.)
2.9-m (9 ft. 6 in.) Mass Excavating with Mass-Excavating Boom	12.42 m (40 ft. 9 in.)
<b>B</b> Overall Height with Arm	
3.6 m (11 ft. 10 in.)	4.46 m (14 ft. 8 in.)
4.2 m (13 ft. 9 in.)	4.98 m (16 ft. 4 in.)
5.3 m (17 ft. 5 in.)	5.28 m (17 ft. 4 in.)
2.9-m (9 ft. 6 in.) Mass Excavating with Mass-Excavating Boom	4.96 m (16 ft. 3 in.)
<b>C</b> Rear-End Length/Swing Radius	3.91 m (12 ft. 10 in.)
<b>D</b> Distance Between Idler/Sprocket Centerline	4.60 m (15 ft. 1 in.)
<b>E</b> Undercarriage Length	5.84 m (19 ft. 2 in.)
<b>F</b> Counterweight Clearance	1.53 m (5 ft. 0 in.)
<b>G</b> Upperstructure Width	4.09 m (13 ft. 5 in.)
<b>H</b> Cab Height	3.66 m (11 ft. 4 in.)
<b>I</b> Track Width with Double-Bar Grouser Shoes	650 mm (26 in.) / 750 mm (30 in.) / 900 mm (36 in.)
<b>J</b> Gauge Width	
Operating Position	3.30 m (10 ft. 10 in.)
Transport Position	2.82 m (9 ft. 3 in.)
<b>K</b> Ground Clearance	0.86 m (34 in.)
<b>L</b> Overall Width with 900-mm (36 in.) Double-Bar Grouser Shoes	
Operating Position	4.19 m (13 ft. 9 in.)
Transport Position	3.73 m (12 ft. 3 in.)

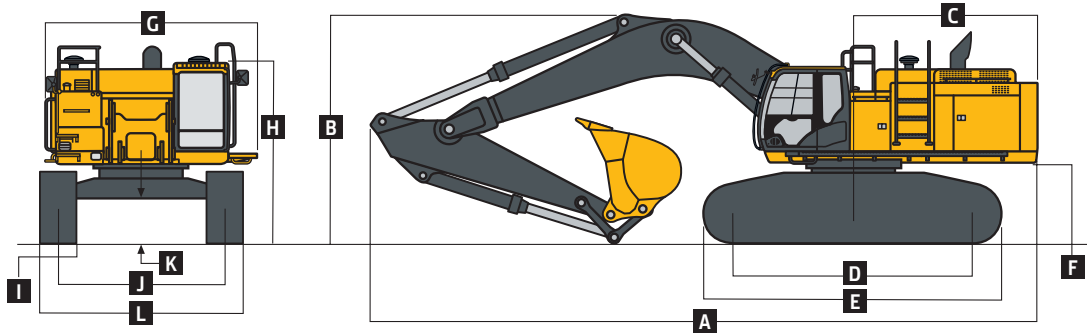
**Packing Dimensions and Weights For Transportation**

	Length	Height	Overall Width	Weight
<b>Base Machine (without front attachment and side frame)*</b>	5.22 m (17 ft. 2 in.)	3.32 m (10 ft. 11 in.)	3.39 m (11 ft. 1 in.)	20 100 kg (44,313 lb.)
<b>Side Frame**</b>				
650-mm (26 in.) Shoe Width	5.84 m (19 ft. 2 in.)	1.45 m (4 ft. 9 in.)	1.19 m (3 ft. 11 in.)	10 300 kg (22,708 lb.)
750-mm (30 in.) Shoe Width	5.84 m (19 ft. 2 in.)	1.45 m (4 ft. 9 in.)	1.24 m (4 ft. 1 in.)	10 600 kg (23,369 lb.)
900-mm (36 in.) Shoe Width	5.84 m (19 ft. 2 in.)	1.45 m (4 ft. 9 in.)	1.32 m (4 ft. 4 in.)	11 100 kg (24,471 lb.)
<b>Counterweight, Standard</b>	3.36 m (11 ft. 0 in.)	1.55 m (5 ft. 1 in.)	0.59 m (23 in.)	11 100 kg (24,471 lb.)
<b>Boom</b>				
6.8 m (22 ft. 4 in.)	7.14 m (23 ft. 5 in.)	2.51 m (8 ft. 3 in.)	1.39 m (4 ft. 7 in.)	6110 kg (13,470 lb.)
7.8 m (25 ft. 7 in.)	8.13 m (26 ft. 8 in.)	2.33 m (7 ft. 8 in.)	1.39 m (4 ft. 7 in.)	6550 kg (14,440 lb.)
<b>Arm</b>				
2.9 m (9 ft. 6 in.)	4.37 m (14 ft. 4 in.)	1.69 m (5 ft. 7 in.)	0.80 m (31 in.)	3620 kg (7,981 lb.)
3.6 m (11 ft. 10 in.)	5.11 m (16 ft. 9 in.)	1.44 m (4 ft. 9 in.)	0.80 m (31 in.)	3620 kg (7,981 lb.)
4.2 m (13 ft. 9 in.)	5.71 m (18 ft. 9 in.)	1.39 m (4 ft. 7 in.)	0.80 m (31 in.)	3930 kg (8,664 lb.)
5.3 m (17 ft. 1 in.)	6.73 m (22 ft. 1 in.)	1.26 m (4 ft. 2 in.)	0.80 m (31 in.)	3620 kg (7,981 lb.)
<b>Less Arm and Counterweight</b>	6.24 m (20 ft. 6 in.)	4.23 m (13 ft. 11 in.) / 3.76 m (12 ft. 4 in.) without exhaust stack	3.48 m (11 ft. 5 in.) with 650-mm (26 in.) shoes / 3.58 m (11 ft. 9 in.) with 750-mm (30 in.) shoes	42 900 kg (94,578 lb.) with 650-mm (26 in.) shoes / 43 300 kg (95,460 lb.) with 750-mm (30 in.) shoes

\*Steps on the track frame and the side hydraulic oil tank, handrails on the upper battery box, upper fuel tank, and the side hydraulic oil tank must be removed to comply with the overall width dimensions above.

\*\*The dimensions and the weights indicate those of one side frame.

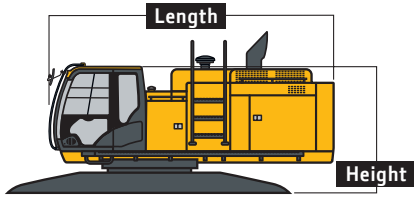

Base Machine

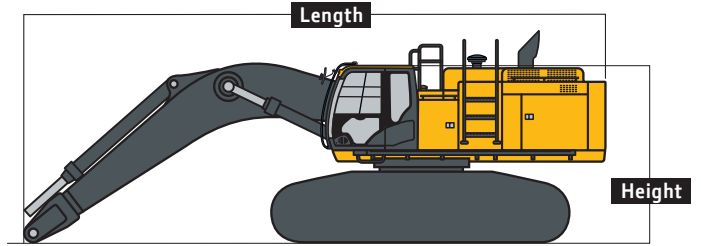

Less Counterweight and Arm

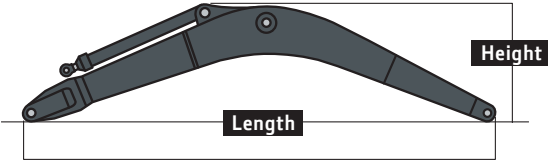

Boom

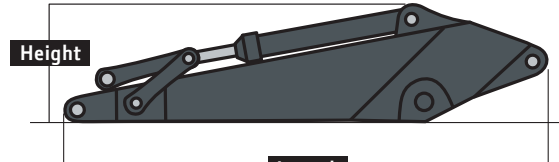

Arm

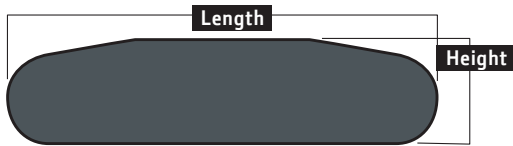

Side Frame

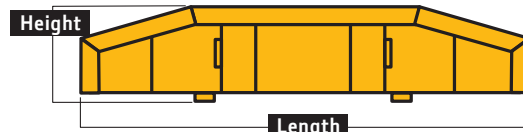

Counterweight

**Lift Capacities**

**Boldface type** indicates hydraulically limited capacity; lightface type indicates stability-limited capacities, in kg (lb.). Ratings at bucket lift hook; machine equipped with standard gauge and situated on firm, uniform supporting surface. Total load includes weight of cables, hook, etc. Figures do not exceed 87 percent of hydraulic capacities or 75 percent of weight needed to tip machine. All lift capacities are based on ISO 10567 (with power boost).

Load Point Height	3.0 m (10 ft.)		4.5 m (15 ft.)		6.0 m (20 ft.)		7.5 m (25 ft.)		9.0 m (30 ft.)		10.5 m (35 ft.)	
	Over Front	Over Side	Over Front	Over Side	Over Front	Over Side	Over Front	Over Side	Over Front	Over Side	Over Front	Over Side

With 2.5-m<sup>3</sup> (3.3 cu. yd.) bucket, 4.2-m (13 ft. 9 in.) arm, 7.8-m (25 ft. 7 in.) boom, and 650-mm (26 in.) double-bar grouser shoes

7.5 m (25 ft.)									<b>10 877</b> (23,789)	<b>10 877</b> (23,789)		
6.0 m (20 ft.)									<b>11 695</b> (25,455)	<b>11 695</b> (25,455)	<b>10 074</b> (20,249)	8822 (18,828)
4.5 m (15 ft.)					18 419 (39,595)	18 419 (39,595)	14 846 (32,081)	14 846 (32,081)	12 770 (27,710)	11 434 (24,562)	11 489 (25,022)	8600 (18,394)
3.0 m (10 ft.)					21 775 (46,868)	21 060 (45,389)	16 786 (36,258)	14 767 (31,793)	13 935 (30,192)	10 914 (23,454)	12 146 (26,076)	8297 (17,780)
1.5 m (5 ft.)					24 280 (52,394)	19 840 (42,717)	18 421 (39,817)	14 015 (30,161)	14 970 (32,415)	10 443 (22,442)	11 847 (25,435)	8011 (17,176)
Ground Line			14 147 (32,798)	14 147 (32,798)	25 552 (55,264)	19 118 (41,112)	19 474 (42,128)	13 480 (28,992)	14 937 (32,099)	10 081 (21,662)	11 611 (24,941)	7789 (16,710)
-1.5 m (-5 ft.)	10 795 (24,434)	10 795 (24,434)	19 888 (45,601)	19 888 (45,601)	25 665 (55,570)	18 795 (40,387)	19 742 (42,409)	13 178 (28,333)	14 702 (31,598)	9864 (21,196)	11 488 (24,701)	7673 (16,485)
-3.0 m (-10 ft.)	17 778 (40,167)	17 778 (40,167)	27 898 (63,882)	27 898 (63,882)	24 708 (53,469)	18 764 (40,316)	19 274 (41,640)	13 097 (28,162)	14 647 (31,502)	9813 (21,107)		
-4.5 m (-15 ft.)	26 090 (59,144)	26 090 (59,144)	29 339 (63,392)	29 339 (63,392)	22 538 (48,598)	18 985 (40,816)	17 625 (37,853)	13 238 (28,498)	13 567 (28,680)	9987 (21,554)		
-6.0 m (-20 ft.)			23 967 (51,241)	23 967 (51,241)	18 551 (39,462)	18 551 (39,462)	13 914 (28,969)	13 697 (28,969)				

**Lift Capacities (continued) 670G LC**

**Boldface type** indicates hydraulically limited capacity; **lightface type** indicates stability-limited capacities, in kg (lb.). Ratings at bucket lift hook; machine equipped with standard gauge and situated on firm, uniform supporting surface. Total load includes weight of cables, hook, etc. Figures do not exceed 87 percent of hydraulic capacities or 75 percent of weight needed to tip machine. All lift capacities are based on ISO 10567 (with power boost).

Load Point Height	3.0 m (10 ft.)		4.5 m (15 ft.)		6.0 m (20 ft.)		7.5 m (25 ft.)		9.0 m (30 ft.)		10.5 m (35 ft.)	
Horizontal Distance from Centerline of Rotation	Over Front	Over Side	Over Front	Over Side	Over Front	Over Side	Over Front	Over Side	Over Front	Over Side	Over Front	Over Side
<i>With 3.5-m<sup>3</sup> (4.6 cu. yd.) bucket, 2.9-m (9 ft. 6 in.) BE arm, 6.8-m (22 ft. 4 in.) BE boom, and 650-mm (26 in.) double-bar grouser shoes</i>												
7.5 m (25 ft.)							<b>14 395</b>	<b>14 395</b>				
							(31,612)	(31,612)				
6.0 m (20 ft.)			<b>17 527</b>	<b>17 527</b>	<b>15 276</b>	<b>15 276</b>						
			(37,885)	(37,885)	(33,224)	(33,224)						
4.5 m (15 ft.)			<b>20 472</b>	<b>20 472</b>	<b>16 699</b>	15 012	15 012	10 731				
			(44,111)	(44,111)	(36,197)	(32,260)	(31,942)	(22,921)				
3.0 m (10 ft.)			<b>23 433</b>	20 710	<b>18 261</b>	14 337	15 341	10 437				
			(50,516)	(44,580)	(39,522)	(30,822)	(32,915)	(22,377)				
1.5 m (5 ft.)			<b>25 431</b>	19 776	<b>19 475</b>	13 778	15 019	10 138				
			(54,940)	(42,529)	(42,140)	(29,614)	(32,245)	(21,754)				
Ground Line			<b>26 021</b>	19 288	<b>19 945</b>	13 427	14 832	9965				
			(56,317)	(41,441)	(43,040)	(28,854)	(31,876)	(21,412)				
-1.5 m (-5 ft.)			<b>33 521</b>	31 688	<b>25 148</b>	19 170	<b>19 302</b>	13 325				
			(72,778)	(67,856)	(54,427)	(41,173)	(41,640)	(28,645)				
-3.0 m (-10 ft.)	<b>34 294</b>	<b>34 294</b>	<b>29 559</b>	<b>29 559</b>	<b>22 510</b>	19 382	<b>16 667</b>	13 551				
	(77,983)	(77,983)	(63,977)	(63,977)	(48,496)	(41,653)	(35,284)	(29,217)				
-4.5 m (-15 ft.)			<b>22 634</b>	<b>22 634</b>	<b>16 493</b>	<b>16 493</b>						
			(48,277)	(48,277)	(34,298)	(34,298)						
<i>With 2.5-m<sup>3</sup> (3.3 cu. yd.) bucket, 4.2-m (13 ft. 9 in.) arm, 7.8-m (25 ft. 7 in.) boom, and 750-mm (30 in.) double-bar grouser shoes</i>												
7.5 m (25 ft.)									<b>10 877</b>	<b>10 877</b>		
									(23,789)	(23,789)		
6.0 m (20 ft.)									<b>11 695</b>	<b>11 695</b>	<b>10 074</b>	8879
									(25,455)	(25,455)	(20,249)	(18,952)
4.5 m (15 ft.)					<b>18 419</b>	<b>18 419</b>	<b>14 846</b>	<b>14 846</b>	<b>12 770</b>	11 503	<b>11 489</b>	8657
					(39,595)	(39,595)	(32,081)	(32,081)	(27,710)	(24,712)	(25,022)	(18,518)
3.0 m (10 ft.)					<b>21 775</b>	21 178	<b>16 786</b>	14 854	<b>13 935</b>	10 983	<b>12 146</b>	8354
					(46,868)	(45,643)	(36,258)	(31,981)	(30,192)	(23,603)	(26,249)	(17,903)
1.5 m (5 ft.)					<b>24 280</b>	19 958	<b>18 421</b>	14 102	<b>14 970</b>	10 512	11 927	8068
					(52,394)	(42,971)	(39,817)	(30,349)	(32,415)	(22,591)	(25,608)	(17,300)
Ground Line			<b>14 147</b>	<b>14 147</b>	<b>25 552</b>	19 236	<b>19 474</b>	13 567	15 035	10 150	11 691	7846
			(32,798)	(32,798)	(55,264)	(41,112)	(42,128)	(28,992)	(32,311)	(21,662)	(25,114)	(16,710)
-1.5 m (-5 ft.)	<b>10 795</b>	<b>10 795</b>	<b>19 888</b>	<b>19 888</b>	<b>25 665</b>	18 912	<b>19 798</b>	13 265	14 800	9933	11 568	7730
	(24,434)	(24,434)	(45,601)	(45,601)	(55,570)	(40,642)	(42,681)	(28,521)	(31,810)	(21,346)	(24,874)	(16,608)
-3.0 m (-10 ft.)	<b>17 778</b>	<b>17 778</b>	<b>27 898</b>	<b>27 898</b>	<b>24 708</b>	18 882	<b>19 274</b>	13 184	14 745	9882		
	(40,167)	(40,167)	(63,882)	(63,882)	(53,469)	(40,570)	(41,640)	(28,350)	(31,713)	(21,256)		
-4.5 m (-15 ft.)	<b>26 090</b>	<b>26 090</b>	<b>29 339</b>	<b>29 339</b>	<b>22 538</b>	19 103	<b>17 625</b>	13 325	<b>13 567</b>	10 056		
	(59,144)	(59,144)	(63,392)	(63,392)	(48,598)	(41,070)	(37,853)	(28,686)	(28,680)	(21,703)		
-6.0 m (-20 ft.)			<b>23 967</b>	<b>23 967</b>	<b>18 551</b>	<b>18 551</b>	<b>13 914</b>	<b>13 784</b>				
			(51,241)	(51,241)	(39,462)	(39,462)	(28,969)	(28,969)				
<i>With 2.9-m<sup>3</sup> (3.8 cu. yd.) bucket, 3.6-m (11 ft. 10 in.) arm, 7.8-m (25 ft. 7 in.) boom, and 900-mm (36 in.) double-bar grouser shoes</i>												
7.5 m (25 ft.)									<b>11 737</b>	<b>11 737</b>		
									(25,696)	(25,696)		
6.0 m (20 ft.)							<b>13 984</b>	<b>13 984</b>	<b>12 459</b>	11 908		
							(30,277)	(30,277)	(27,118)	(25,550)		
4.5 m (15 ft.)					<b>19 903</b>	<b>19 903</b>	<b>15 769</b>	15 613	<b>13 440</b>	11 455	<b>12 043</b>	8611
					(42,762)	(42,762)	(34,065)	(33,620)	(29,162)	(24,611)	(23,250)	(18,398)
3.0 m (10 ft.)					<b>23 023</b>	20 966	<b>17 563</b>	14 793	<b>14 488</b>	10 978	<b>12 293</b>	8368
					(49,548)	(45,200)	(37,932)	(31,856)	(31,388)	(23,595)	(26,380)	(17,930)
1.5 m (5 ft.)					<b>25 061</b>	19 939	<b>18 974</b>	14 126	<b>15 369</b>	10 560	<b>12 038</b>	8128
					(54,098)	(42,929)	(41,012)	(30,405)	(33,275)	(22,698)	(25,851)	(17,432)
Ground Line			<b>12 940</b>	<b>12 940</b>	<b>25 788</b>	19 410	<b>19 740</b>	13 687	15 211	10 260	11 861	7961
			(30,246)	(30,246)	(55,807)	(41,737)	(42,704)	(29,442)	(32,695)	(22,052)	(25,491)	(17,093)
-1.5 m (-5 ft.)			<b>21 022</b>	<b>21 022</b>	<b>25 394</b>	19 236	<b>19 730</b>	13 479	15 050	10 111		
			(48,226)	(48,226)	(55,010)	(41,334)	(42,682)	(28,984)	(32,358)	(21,738)		
-3.0 m (-10 ft.)	<b>20 323</b>	<b>20 323</b>	<b>31 007</b>	<b>31 007</b>	<b>23 941</b>	19 319	<b>18 793</b>	13 487	<b>14 834</b>	10 147		
	(45,939)	(45,939)	(67,288)	(67,288)	(51,811)	(41,514)	(40,564)	(29,012)	(31,798)	(21,850)		
-4.5 m (-15 ft.)	<b>30 660</b>	<b>30 660</b>	<b>27 015</b>	<b>27 015</b>	<b>21 158</b>	19 649	<b>16 490</b>	13 739				
	(69,671)	(69,671)	(58,346)	(58,346)	(45,545)	(42,258)	(35,230)	(29,603)				
-6.0 m (-20 ft.)			<b>20 645</b>	<b>20 645</b>	<b>16 030</b>	<b>16 030</b>						
			(43,853)	(43,853)	(33,647)	(33,647)						



**Lift Capacities (continued) 670G LC**

**Boldface type** indicates hydraulically limited capacity; lightface type indicates stability-limited capacities, in kg (lb.). Ratings at bucket lift hook; machine equipped with standard gauge and situated on firm, uniform supporting surface. Total load includes weight of cables, hook, etc. Figures do not exceed 87 percent of hydraulic capacities or 75 percent of weight needed to tip machine. All lift capacities are based on ISO 10567 (with power boost).

Load Point Height	3.0 m (10 ft.)		4.5 m (15 ft.)		6.0 m (20 ft.)		7.5 m (25 ft.)		9.0 m (30 ft.)		10.5 m (35 ft.)	
	Over Front	Over Side	Over Front	Over Side	Over Front	Over Side	Over Front	Over Side	Over Front	Over Side	Over Front	Over Side

*With 2.5-m<sup>3</sup> (3.3 cu. yd.) bucket, 4.2-m (13 ft. 9 in.) arm, 7.8-m (25 ft. 7 in.) boom, and 900-mm (36 in.) double-bar grouser shoes*

7.5 m (25 ft.)									<b>10 880</b>	<b>10 880</b>		
									<b>(23,800)</b>	<b>(23,800)</b>		
6.0 m (20 ft.)									<b>11 700</b>	<b>11 700</b>	<b>10 070</b>	9030
									<b>(25,500)</b>	<b>(25,500)</b>	<b>(20,300)</b>	(19,300)
4.5 m (15 ft.)					<b>18 420</b>	<b>18 420</b>	<b>14 850</b>	<b>14 850</b>	<b>12 770</b>	11 690	<b>11 490</b>	8810
					<b>(39,600)</b>	<b>(39,600)</b>	<b>(32,100)</b>	<b>(32,100)</b>	<b>(27,700)</b>	(25,100)	<b>(22,500)</b>	(18,900)
3.0 m (10 ft.)					<b>21 780</b>	21 500	<b>16 790</b>	15 090	<b>13 940</b>	11 170	<b>12 150</b>	8510
					<b>(46,900)</b>	(46,300)	<b>(36,300)</b>	(32,500)	<b>(30,200)</b>	(24,000)	<b>(26,400)</b>	(18,200)
1.5 m (5 ft.)					<b>24 280</b>	20 280	<b>18 420</b>	14 340	<b>14 970</b>	10 700	<b>12 140</b>	8220
					<b>(52,400)</b>	(43,700)	<b>(39,800)</b>	(30,900)	<b>(32,400)</b>	(23,000)	<b>(26,100)</b>	(17,600)
Ground Line			14 150	14 150	25 550	19 560	<b>19 470</b>	13 800	15 300	10 340	11 900	8000
			<b>(32,800)</b>	<b>(32,800)</b>	<b>(55,300)</b>	(42,100)	<b>(42,100)</b>	(29,700)	<b>(32,900)</b>	(22,200)	<b>(25,600)</b>	(17,200)
-1.5 m (-5 ft.)	<b>10 800</b>	<b>10 800</b>	19 890	19 890	25 670	19 230	<b>19 800</b>	13 500	15 060	10 120	11 780	7890
	<b>(24,400)</b>	<b>(24,400)</b>	<b>(45,600)</b>	<b>(45,600)</b>	<b>(55,600)</b>	(41,300)	<b>(42,800)</b>	(29,000)	<b>(32,400)</b>	(21,800)	<b>(25,300)</b>	(16,900)
-3.0 m (-10 ft.)	<b>17 780</b>	<b>17 780</b>	27 900	27 900	24 710	19 200	<b>19 270</b>	13 420	15 010	10 070		
	<b>(40,200)</b>	<b>(40,200)</b>	<b>(63,900)</b>	<b>(63,900)</b>	<b>(53,500)</b>	(41,300)	<b>(41,600)</b>	(28,900)	<b>(32,300)</b>	(21,700)		
-4.5 m (-15 ft.)	<b>26 090</b>	<b>26 090</b>	29 340	29 340	22 540	19 420	<b>17 630</b>	13 560	<b>13 570</b>	10 240		
	<b>(59,100)</b>	<b>(59,100)</b>	<b>(63,400)</b>	<b>(63,400)</b>	<b>(48,600)</b>	(41,800)	<b>(37,900)</b>	(29,200)	<b>(28,700)</b>	(22,100)		
-6.0 m (-20 ft.)			23 970	23 970	18 550	18 550	13 910	13 910				
			<b>(51,200)</b>	<b>(51,200)</b>	<b>(39,500)</b>	<b>(39,500)</b>	<b>(29,000)</b>	<b>(29,000)</b>				

*With 2.0-m<sup>3</sup> (2.6 cu. yd.) bucket, 5.3-m (17 ft. 5 in.) arm, 7.8-m (25 ft. 7 in.) boom, and 900-mm (36 in.) double-bar grouser shoes*

9.0 m (30 ft.)											<b>6009</b>	<b>6009</b>
											<b>(11,573)</b>	<b>(11,573)</b>
7.5 m (25 ft.)											<b>7633</b>	<b>7633</b>
											<b>(16,037)</b>	<b>(16,037)</b>
6.0 m (20 ft.)									<b>9950</b>	<b>9950</b>	<b>8901</b>	<b>8901</b>
									<b>(21,588)</b>	<b>(21,588)</b>	<b>(18,979)</b>	<b>(18,979)</b>
4.5 m (15 ft.)							<b>13 443</b>	<b>13 443</b>	11 864	11 864	10 429	9496
							<b>(29,087)</b>	<b>(29,087)</b>	<b>(25,768)</b>	<b>(25,768)</b>	<b>(22,249)</b>	(20,365)
3.0 m (10 ft.)			<b>27 858</b>	<b>27 858</b>	19 701	19 701	15 613	15 613	13 211	11 922	<b>11 668</b>	9138
			<b>(59,723)</b>	<b>(59,723)</b>	<b>(42,441)</b>	<b>(42,441)</b>	<b>(33,756)</b>	<b>(33,756)</b>	<b>(28,648)</b>	(25,636)	<b>(25,370)</b>	(19,608)
1.5 m (5 ft.)			<b>17 982</b>	<b>17 982</b>	22 902	21 457	<b>17 611</b>	15 185	<b>14 493</b>	11 368	<b>12 479</b>	8786
			<b>(42,685)</b>	<b>(42,685)</b>	<b>(49,431)</b>	(46,208)	<b>(38,090)</b>	(32,691)	<b>(31,408)</b>	(24,446)	<b>(27,092)</b>	(18,859)
Ground Line			16 168	16 168	25 049	20 401	<b>19 134</b>	14 486	<b>15 522</b>	10 905	12 398	8485
			<b>(37,320)</b>	<b>(37,320)</b>	<b>(54,167)</b>	(43,894)	<b>(41,411)</b>	(31,172)	<b>(33,628)</b>	(23,447)	<b>(26,642)</b>	(18,217)
-1.5 m (-5 ft.)	<b>10 052</b>	<b>10 052</b>	18 748	18 748	26 037	19 791	<b>20 004</b>	14 018	15 526	10 574	12 169	8269
	<b>(22,701)</b>	<b>(22,701)</b>	<b>(42,960)</b>	<b>(42,960)</b>	<b>(56,367)</b>	(42,552)	<b>(43,307)</b>	(30,154)	<b>(33,379)</b>	(22,735)	<b>(26,160)</b>	(17,762)
-3.0 m (-10 ft.)	<b>14 711</b>	<b>14 711</b>	23 606	23 606	25 938	19 532	<b>20 117</b>	13 777	15 333	10 396	12 064	8170
	<b>(33,198)</b>	<b>(33,198)</b>	<b>(53,968)</b>	<b>(53,968)</b>	<b>(56,149)</b>	(41,985)	<b>(43,523)</b>	(29,635)	<b>(32,975)</b>	(22,359)	<b>(25,958)</b>	(17,572)
-4.5 m (-15 ft.)	<b>20 335</b>	<b>20 335</b>	30 826	30 826	24 730	19 554	<b>19 330</b>	13 751	15 326	10 389		
	<b>(46,013)</b>	<b>(46,013)</b>	<b>(70,608)</b>	<b>(68,371)</b>	<b>(53,432)</b>	(42,044)	<b>(41,701)</b>	(29,595)	<b>(32,988)</b>	(22,372)		
-6.0 m (-20 ft.)	<b>27 672</b>	<b>27 672</b>	29 088	29 088	22 149	19 843	<b>17 275</b>	13 957	<b>13 248</b>	10 618		
	<b>(62,903)</b>	<b>(62,903)</b>	<b>(62,555)</b>	<b>(62,555)</b>	<b>(47,558)</b>	(42,706)	<b>(36,921)</b>	(30,084)	<b>(27,798)</b>	(22,951)		
-7.5 m (-25 ft.)			22 773	22 773	17 355	17 355						
			<b>(48,117)</b>	<b>(48,117)</b>	<b>(36,413)</b>	<b>(36,413)</b>						

*With 3.5-m<sup>3</sup> (4.6 cu. yd.) bucket, 2.9-m (9 ft. 6 in.) BE arm, 6.8-m (22 ft. 4 in.) BE boom, and 900-mm (36 in.) double-bar grouser shoes*

7.5 m (25 ft.)								<b>14 395</b>	<b>14 395</b>			
								<b>(31,612)</b>	<b>(31,612)</b>			
6.0 m (20 ft.)					<b>17 527</b>	<b>17 527</b>	<b>15 276</b>	<b>15 276</b>				
					<b>(37,885)</b>	<b>(37,885)</b>	<b>(33,224)</b>	<b>(33,224)</b>				
4.5 m (15 ft.)					<b>20 472</b>	<b>20 472</b>	<b>16 699</b>	15 334	<b>14 652</b>	10 986		
					<b>(44,111)</b>	<b>(44,111)</b>	<b>(36,197)</b>	(32,957)	<b>(31,942)</b>	(23,474)		
3.0 m (10 ft.)					<b>23 433</b>	21 147	<b>18 261</b>	14 660	<b>15 368</b>	10 693		
					<b>(50,516)</b>	(45,523)	<b>(39,522)</b>	(31,520)	<b>(33,393)</b>	(22,931)		
1.5 m (5 ft.)					<b>25 431</b>	20 214	<b>19 475</b>	14 101	<b>15 377</b>	10 394		
					<b>(54,940)</b>	(43,472)	<b>(42,140)</b>	(30,312)	<b>(33,018)</b>	(22,308)		
Ground Line					<b>26 021</b>	19 726	<b>19 945</b>	13 750	15 190	10 220		
					<b>(56,317)</b>	(42,385)	<b>(43,144)</b>	(29,551)	<b>(32,649)</b>	(21,965)		
-1.5 m (-5 ft.)			<b>33 521</b>	32 367	<b>25 148</b>	19 608	<b>19 302</b>	13 648				
			<b>(72,778)</b>	(69,314)	<b>(54,427)</b>	(42,117)	<b>(41,640)</b>	(29,342)				
-3.0 m (-10 ft.)	<b>34 294</b>	<b>34 294</b>	<b>29 559</b>	<b>29 559</b>	<b>22 510</b>	19 819	<b>16 667</b>	13 874				
	<b>(77,983)</b>	<b>(77,983)</b>	<b>(63,977)</b>	<b>(63,977)</b>	<b>(48,496)</b>	(42,597)	<b>(35,284)</b>	(29,914)				
-4.5 m (-15 ft.)			<b>22 634</b>	<b>22 634</b>	<b>16 493</b>	<b>16 493</b>						
			<b>(48,277)</b>	<b>(48,277)</b>	<b>(34,298)</b>	<b>(34,298)</b>						

## Buckets 670G LC

A full line of buckets is offered to meet a wide variety of applications. Digging forces are with power boost. Tooth selection includes the John Deere Fanggs™ Standard, Tiger, Twin Tiger, Abrasion panel, or Flare tooth. Replaceable cutting edges and a variety of teeth are available through John Deere Parts. Optional side cutters add 150 mm (6 in.) to bucket widths. Capacities are SAE heaped ratings.

Type Bucket	Bucket Width		Bucket Capacity		Bucket Weight		Bucket Dig Force (SAE)		Bucket Dig Force (ISO)		Arm Dig Force 3.6 m (11 ft. 10 in.) (SAE)		Arm Dig Force 3.6 m (11 ft. 10 in.) (ISO)	
	mm	in.	m <sup>3</sup>	cu. yd.	kg	lb.	kN	lb.	kN	lb.	kN	lb.	kN	lb.
Extreme Duty Plate Lip	1219	48	2.65	3.5	3396	7,487	275	61,851	307	69,102	242	54,423	250	56,186
Extreme Duty Plate Lip	1370	54	3.06	4.0	3546	7,817	275	61,851	307	69,102	242	54,423	250	56,186
Extreme Duty Plate Lip	1524	60	3.53	4.6	3795	8,368	275	61,851	307	69,102	242	54,423	250	56,186
Heavy Duty High Capacity	914	36	1.80	2.4	2664	5,873	275	61,851	307	69,102	242	54,423	250	56,186
Heavy Duty High Capacity	1067	42	2.22	2.9	2867	6,320	275	61,851	307	69,102	242	54,423	250	56,186
Heavy Duty High Capacity	1219	48	2.06	2.7	2966	6,540	275	61,851	307	69,102	242	54,423	250	56,186
Heavy Duty High Capacity	1370	54	3.09	4.0	3129	6,898	275	61,851	307	69,102	242	54,423	250	56,186
Heavy Duty High Capacity	1524	60	3.54	4.6	3302	7,280	275	61,851	307	69,102	242	54,423	250	56,186
Heavy Duty High Capacity	1829	72	4.44	5.8	3593	7,921	275	61,851	307	69,102	242	54,423	250	56,186
Heavy Duty High Capacity	2032	80	5.05	6.6	3916	8,634	275	61,851	307	69,102	242	54,423	250	56,186
Heavy Capacity Dirt	2184	86	4.59	6.0	3941	8,688	287	64,421	320	71,973	246	55,278	254	57,069
Heavy Duty	914	36	1.30	1.7	2252	4,964	326	73,327	364	81,924	258	57,940	266	59,817
Heavy Duty	1067	42	1.58	2.1	2594	5,719	326	73,327	364	81,924	258	57,940	266	59,817
Heavy Duty	1219	48	1.90	2.5	2722	6,000	326	73,327	364	81,924	258	57,940	266	59,817
Heavy Duty	1370	54	2.19	2.9	2858	6,302	326	73,327	364	81,924	258	57,940	266	59,817
Heavy Duty	1524	60	2.52	3.3	3062	6,750	326	73,327	364	81,924	258	57,940	266	59,817
Truck Loading	1930	76	3.75	4.9	3043	6,709	287	64,421	320	71,973	246	55,278	254	57,069
Truck Loading	2083	82	4.05	5.3	3292	7,257	287	64,421	320	71,973	246	55,278	254	57,069

### Bucket Selection Guide\*

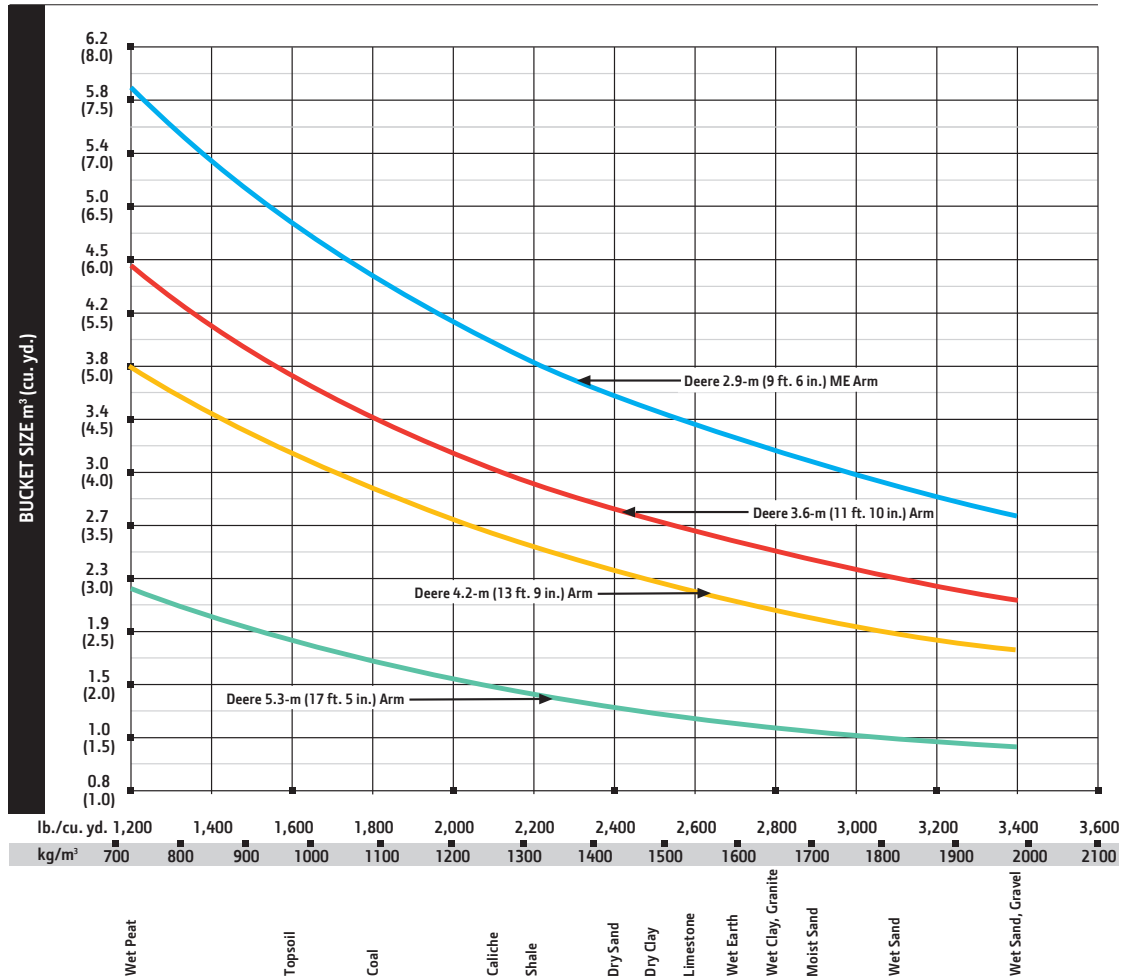

\*Contact your John Deere dealer for optimum bucket and attachment selections. These recommendations are for general conditions and average use. Does not include optional equipment such as thumbs or couplers. Larger buckets may be possible when using light materials, for flat and level operations, less compacted materials, and volume loading applications such as mass excavation applications in ideal conditions. Smaller buckets are recommended for adverse conditions such as off-level applications, rocks, and uneven surfaces. Bucket capacity indicated is SAE heaped.

Arm Dig Force 4.2 m (13 ft. 9 in.) (SAE)		Arm Dig Force 4.2 m (13 ft. 9 in.) (ISO)		Arm Dig Force 5.3 m (17 ft. 5 in.) (SAE)		Arm Dig Force 5.3 m (17 ft. 5 in.) (ISO)		ME Arm Dig Force 2.9 m (9 ft. 6 in.) (SAE)		ME Arm Dig Force 2.9 m (9 ft. 6 in.) (ISO)		Bucket Tip Radius		Number of Teeth
kN	lb.	kN	lb.	kN	lb.	kN	lb.	kN	lb.	kN	lb.	mm	in.	
220	49,448	227	50,993	189	42,497	193	43,383	290	65,260	299	67,238	2281	89.79	3
220	49,448	227	50,993	189	42,497	193	43,383	290	65,260	299	67,238	2281	89.79	3
220	49,448	227	50,993	189	42,497	193	43,383	290	65,260	299	67,238	2281	89.79	3
220	49,448	227	50,993	189	42,497	193	43,383	290	65,260	299	67,238	2281	89.79	3
220	49,448	227	50,993	189	42,497	193	43,383	290	65,260	299	67,238	2281	89.79	3
220	49,448	227	50,993	189	42,497	193	43,383	290	65,260	299	67,238	2281	89.79	4
220	49,448	227	50,993	189	42,497	193	43,383	290	65,260	299	67,238	2281	89.79	5
220	49,448	227	50,993	189	42,497	193	43,383	290	65,260	299	67,238	2281	89.79	5
220	49,448	227	50,993	189	42,497	193	43,383	290	65,260	299	67,238	2281	89.79	6
220	49,448	227	50,993	189	42,497	193	43,383	290	65,260	299	67,238	2281	89.79	6
223	50,152	230	51,720	58	13,013	195	43,910	295	66,427	304	68,440	2190	86.23	6
233	52,331	240	53,996	198	44,597	203	45,526	312	70,090	321	72,214	1924	75.75	3
233	52,331	240	53,996	198	44,597	203	45,526	312	70,090	321	72,214	1924	75.75	4
233	52,331	240	53,996	198	44,597	203	45,526	312	70,090	321	72,214	1924	75.75	4
233	52,331	240	53,996	198	44,597	203	45,526	312	70,090	321	72,214	1924	75.75	5
233	52,331	240	53,996	198	44,597	203	45,526	312	70,090	321	72,214	1924	75.75	5
223	50,152	230	51,720	58	13,013	195	43,910	295	66,427	304	68,440	2189	86.20	6
223	50,152	230	51,720	58	13,013	195	43,910	295	66,427	304	68,440	2189	86.20	7

# 870G LC



<b>Engine</b>	<b>870G LC</b>		
Manufacturer and Model	Isuzu 6WG1-iT4		
Non-Road Emissions Standard	EPA Interim Tier 4/EU Stage IIIB		
Net Rated Power (ISO 9249)	397 kW (532 hp) at 1,800 rpm		
Cylinders	6		
Displacement	15.7 L (957 cu. in.)		
Off-Level Capacity	70% (35 deg.)		
Aspiration	Turbocharged, air-to-air charge-air cooler		
<b>Cooling</b>			
Cool-on-demand hydraulic-driven, suction-type fan with remote-mounted drive			
<b>Powertrain</b>			
2-speed propel with Autoshift			
<b>Maximum Travel Speed</b>			
Low	3.2 km/h (2.0 mph)		
High	4.7 km/h (2.9 mph)		
Drawbar Pull	57 240 kg (126,193 lb.)		
<b>Hydraulics</b>			
Open center, load sensing			
<b>Main Pumps</b>	2 variable-displacement pumps		
Maximum Rated Flow	566 L/m (150 gpm) x 2		
<b>Pilot Pump</b>	One gear		
Maximum Rated Flow	30 L/m (7.9 gpm)		
Pressure Setting	3900 kPa (566 psi)		
<b>System Operating Pressure</b>			
Circuits			
Implement	31 900 kPa (4,627 psi)		
Travel	34 300 kPa (4,975 psi)		
Swing	29 400 kPa (4,264 psi)		
Power Boost	34 300 kPa (4,975 psi)		
<b>Controls</b>	Pilot levers, short stroke, low-effort hydraulic pilot controls with shutoff lever		
<b>Cylinders</b>			
Heat-treated, chrome-plated, polished cylinder rods; hardened steel (replaceable bushings) pivot pins			
	<i>Bore</i>	<i>Rod Diameter</i>	<i>Stroke</i>
<b>Boom (2)</b>	215 mm (8.5 in.)	150 mm (5.9 in.)	1835 mm (72.2 in.)
<b>Arm (1)</b>	225 mm (8.9 in.)	160 mm (6.3 in.)	2225 mm (87.6 in.)
<b>Bucket (1)</b>	200 mm (7.9 in.)	140 mm (5.5 in.)	1555 mm (61.2 in.)
<b>Electrical</b>			
Number of Batteries (12 volt)	2		
Battery Capacity	500 CCA		
Alternator Rating	50 amp		
Work Lights	5 halogen (one mounted on frame, 2 mounted on boom, and 2 mounted on top of cab)		
<b>Undercarriage</b>			
<b>Rollers (each side)</b>			
Carrier	3		
Track	9		
Shoes, Double-Bar Grousers (each side)	51		
<b>Track</b>			
Adjustment	Hydraulic		
Guides	Front and center		
Chain	Sealed and lubricated		
<b>Ground Pressure</b>			
Double-Bar Grouser Shoes			
650 mm (26 in.)	115.3 kPa (16.7 psi)		
750 mm (30 in.)	100.7 kPa (14.6 psi)		
900 mm (36 in.)	84.8 kPa (12.3 psi)		
1020 mm (40 in.)	77.2 kPa (11.2 psi)		



<b>Swing Mechanism</b>	<b>870G LC</b>
Speed	7.8 rpm
Torque	267 000 Nm (196,929 lb.-ft.)

**Serviceability**

<b>Refill Capacities</b>	
Fuel Tank	1110 L (293 gal.)
Cooling System	112 L (29.6 gal.)
Engine Oil with Filter	57 L (15.1 gal.)
Hydraulic Tank	500 L (132.1 gal.)
Hydraulic System	1042 L (275.3 gal.)
<b>Gearbox</b>	
Swing (each)	15 L (15.9 qt.)
Travel (each)	19 L (20.1 qt.)
Pump Drive	6.2 L (6.6 qt.)

**Operating Weights**

With full fuel tank; 79-kg (175 lb.) operator; 3.49-m<sup>3</sup> (4.57 cu. yd.), 1370-mm (54 in.), 3558-kg (7,844 lb.) bucket; 4.4-m (14 ft. 5 in.) arm; 13 300-kg (29,321 lb.) counterweight; and 900-mm (36 in.) double-bar grouser shoes

SAE Operating Weight	87 659 kg (193,255 lb.)
----------------------	-------------------------

**Component Weights**

<b>Undercarriage with Double-Bar Grouser Shoes</b>	
650 mm (26 in.)	32 350 kg (71,320 lb.)
750 mm (30 in.)	33 050 kg (72,863 lb.)
900 mm (36 in.)	33 990 kg (74,935 lb.)
1020 mm (40 in.)	34 420 kg (75,883 lb.)
<b>One-Piece Boom (with arm cylinder)</b>	
8.4 m (27 ft. 7 in.)	8200 kg (18,078 lb.)
7.1-m (23 ft. 4 in.) Mass Excavating	7670 kg (16,909 lb.)
10.0 m (32 ft. 10 in.)	9390 kg (20,701 lb.)
<b>Arm with Bucket Cylinder and Linkage</b>	
3.7 m (12 ft. 1 in.)	4330 kg (9,546 lb.)
4.4 m (14 ft. 5 in.)	4660 kg (10,274 lb.)
5.4 m (17 ft. 9 in.)	4950 kg (10,913 lb.)
2.95-m (9 ft. 8 in.) with 7.1-m (23 ft. 4 in.) Mass-Excavating Boom	4650 kg (10,251 lb.)
<b>Boom-Lift Cylinders (2), Total Weight</b>	
3.49-m <sup>3</sup> (4.57 cu. yd.), 1370-mm (54 in.)	1700 kg (3,748 lb.)
Heavy-Duty High-Capacity Bucket	3558 kg (7,844 lb.)
Counterweight, Standard	13 300 kg (29,321 lb.)

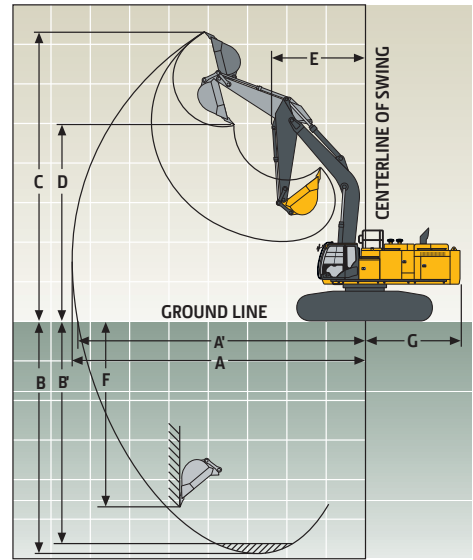

**Operating Dimensions**

<b>Arm Length</b>	3.7 m (12 ft. 2 in.) w/ 8.4-m (27 ft. 7 in.) Boom	4.4 m (14 ft. 5 in.) w/ 8.4-m (27 ft. 7 in.) Boom	5.4 m (17 ft. 9 in.) w/ 8.4-m (27 ft. 7 in.) Boom	2.95-m (9 ft. 8 in.) w/ 7.1-m (23 ft. 4 in.) Mass-Excavating Boom	4.4-m (14 ft. 5 in.) w/ 10.0-m (32 ft. 10 in.) Boom	5.4-m (17 ft. 9 in.) w/ 10.0-m (32 ft. 10 in.) Boom
<b>Arm Digging Force</b>						
SAE	315 kN (70,815 lb.)	273 kN (61,373 lb.)	237 kN (53,280 lb.)	378 kN (84,978 lb.)	273 kN (61,373 lb.)	237 kN (53,280 lb.)
ISO	323 kN (72,613 lb.)	280 kN (62,946 lb.)	243 kN (54,629 lb.)	394 kN (88,575 lb.)	280 kN (62,946 lb.)	243 kN (54,629 lb.)
<b>Bucket Digging Force</b>						
SAE	359 kN (80,706 lb.)	359 kN (80,706 lb.)	289 kN (64,970 lb.)	411 kN (92,396 lb.)	359 kN (80,706 lb.)	289 kN (64,970 lb.)
ISO	399 kN (89,699 lb.)	399 kN (89,699 lb.)	323 kN (72,613 lb.)	472 kN (106,110 lb.)	399 kN (89,699 lb.)	323 kN (72,613 lb.)
<b>Lifting Capacity Over Front at Ground Level</b>						
9.0-m (30 ft.) Reach (with power boost)	20 579 kg (44,499 lb.)	20 260 kg (43,800 lb.)	19 466 kg (42,109 lb.)	20 609 kg (44,450 lb.)	18 919 kg (40,872 lb.)	18 341 kg (40,435 lb.)
<b>A</b>	Maximum Reach	14.10 m (46 ft. 3 in.)	14.91 m (48 ft. 11 in.)	15.91 m (52 ft. 2 in.)	12.34 m (40 ft. 6 in.)	16.55 m (54 ft. 4 in.)
<b>A'</b>	Maximum Reach at Ground Level	13.82 m (45 ft. 4 in.)	14.64 m (48 ft. 0 in.)	15.67 m (51 ft. 5 in.)	12.02 m (39 ft. 5 in.)	16.32 m (53 ft. 7 in.)
<b>B</b>	Maximum Digging Depth	8.87 m (29 ft. 1 in.)	9.57 m (31 ft. 5 in.)	10.57 m (34 ft. 8 in.)	7.14 m (23 ft. 5 in.)	11.16 m (36 ft. 7 in.)
<b>B'</b>	Maximum Digging Depth at 2.44-m (8 ft. 0 in.) Flat Bottom	8.74 m (28 ft. 8 in.)	9.46 m (31 ft. 0 in.)	10.46 m (34 ft. 4 in.)	7.00 m (23 ft. 0 in.)	11.04 m (36 ft. 3 in.)
<b>C</b>	Maximum Cutting Height	13.03 m (42 ft. 9 in.)	13.82 m (45 ft. 4 in.)	14.53 m (47 ft. 8 in.)	12.01 m (39 ft. 5 in.)	14.66 m (48 ft. 1 in.)
<b>D</b>	Maximum Dumping Height	9.08 m (29 ft. 9 in.)	9.73 m (31 ft. 11 in.)	10.41 m (34 ft. 2 in.)	8.13 m (26 ft. 8 in.)	10.81 m (35 ft. 6 in.)
<b>E</b>	Minimum Swing Radius	5.95 m (19 ft. 6 in.)	5.94 m (19 ft. 6 in.)	5.94 m (19 ft. 6 in.)	5.21 m (17 ft. 1 in.)	7.35 m (24 ft. 1 in.)
<b>F</b>	Maximum Vertical Wall	7.17 m (23 ft. 6 in.)	8.48 m (27 ft. 10 in.)	9.75 m (32 ft. 0 in.)	4.10 m (13 ft. 5 in.)	9.87 m (32 ft. 5 in.)
<b>G</b>	Tail-Swing Radius	4.60 m (15 ft. 1 in.)	4.60 m (15 ft. 1 in.)	4.60 m (15 ft. 1 in.)	4.60 m (15 ft. 1 in.)	4.60 m (15 ft. 1 in.)

Machine Dimensions		870G LC
<b>A</b>	Overall Length with Arm	
	3.7 m (12 ft. 2 in.)	14.88 m (48 ft. 10 in.)
	4.4 m (14 ft. 5 in.)	14.80 m (48 ft. 7 in.)
	5.4 m (17 ft. 9 in.)	14.65 m (48 ft. 1 in.)
	2.95-m (9 ft. 8 in.) Mass Excavating with Mass-Excavating Boom	13.55 m (44 ft. 5 in.)
<b>B</b>	Overall Height with Arm	
	3.7 m (12 ft. 2 in.)	4.77 m (15 ft. 8 in.)
	4.4 m (14 ft. 5 in.)	5.13 m (16 ft. 10 in.)
	5.4 m (17 ft. 9 in.)	5.76 m (18 ft. 11 in.)
	2.95-m (9 ft. 8 in.) Mass Excavating with Mass-Excavating Boom	5.20 m (17 ft. 1 in.)
<b>C</b>	Rear-End Length/Swing Radius	4.54 m (14 ft. 11 in.)
<b>D</b>	Distance Between Idler/Sprocket Centerline	5.11 m (16 ft. 9 in.)
<b>E</b>	Undercarriage Length	6.36 m (20 ft. 10 in.)
<b>F</b>	Counterweight Clearance	1.68 m (5 ft. 6 in.)
<b>G</b>	Upperstructure Width	4.12 m (13 ft. 6 in.)
<b>H</b>	Cab Height	3.69 m (12 ft. 1 in.)
<b>I</b>	Track Width with Double-Bar Grouser Shoes	650 mm (26 in.) / 750 mm (30 in.) / 900 mm (36 in.) / 1020 mm (40 in.)
<b>J</b>	Gauge Width	
	Operating Position	3.45 m (11 ft. 4 in.)
	Transport Position	2.83 m (9 ft. 3 in.)
<b>K</b>	Ground Clearance	0.89 m (35 in.)
<b>L</b>	Overall Width with 900-mm (36 in.) Double-Bar Grouser Shoes	
	Operating Position	4.35 m (14 ft. 3 in.)
	Transport Position	3.73 m (12 ft. 3 in.)

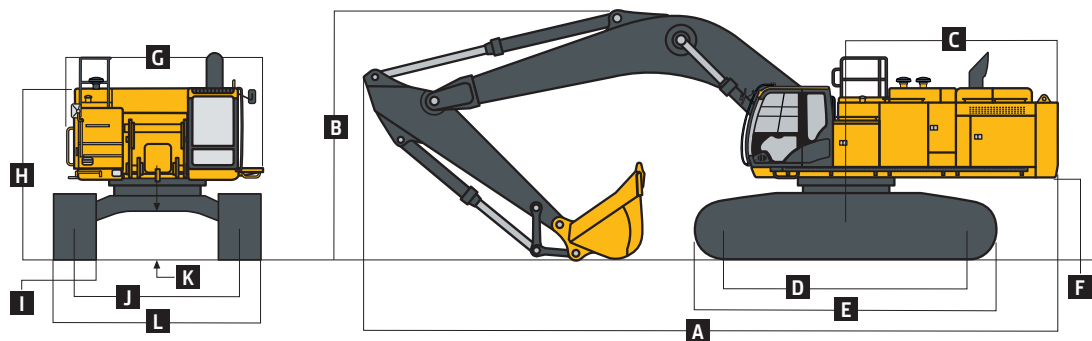

Packing Dimensions and Weights For Transportation				
	Length	Height	Overall Width	Weight
<b>Base Machine (without front attachment and side frame)*</b>	6.04 m (19 ft. 10 in.)	3.49 m (11 ft. 5 in.)	3.39 m (11 ft. 1 in.)	27 400 kg (60,407 lb.)
<b>Side Frame**</b>				
650-mm (26 in.) Shoe Width	6.36 m (20 ft. 10 in.)	1.50 m (4 ft. 11 in.)	1.30 m (4 ft. 3 in.)	12 100 kg (26,676 lb.)
750-mm (30 in.) Shoe Width	6.36 m (20 ft. 10 in.)	1.50 m (4 ft. 11 in.)	1.33 m (4 ft. 4 in.)	12 500 kg (27,558 lb.)
900-mm (36 in.) Shoe Width	6.36 m (20 ft. 10 in.)	1.50 m (4 ft. 11 in.)	1.43 m (4 ft. 8 in.)	12 890 kg (28,418 lb.)
1020-mm (40 in.) Shoe Width	6.36 m (20 ft. 10 in.)	1.50 m (4 ft. 11 in.)	1.45 m (4 ft. 9 in.)	13 320 kg (29,366 lb.)
<b>Counterweight, Standard</b>	3.36 m (11 ft. 0 in.)	1.62 m (5 ft. 4 in.)	0.72 m (28 in.)	13 300 kg (29,321 lb.)
<b>Boom</b>				
7.1 m (23 ft. 4 in.)	7.49 m (24 ft. 7 in.)	2.70 m (8 ft. 10 in.)	1.45 m (4 ft. 9 in.)	7670 kg (16,909 lb.)
8.4 m (27 ft. 7 in.)	8.78 m (28 ft. 10 in.)	2.50 m (8 ft. 2 in.)	1.45 m (4 ft. 9 in.)	8200 kg (18,078 lb.)
10.0 m (32 ft. 10 in.)	10.37 m (34 ft. 0 in.)	2.70 m (8 ft. 10 in.)	1.45 m (4 ft. 9 in.)	9390 kg (20,701 lb.)
<b>Arm</b>				
2.95 m (9 ft. 8 in.)	4.46 m (14 ft. 8 in.)	1.66 m (5 ft. 5 in.)	0.85 m (33 in.)	4650 kg (10,251 lb.)
3.7 m (12 ft. 2 in.)	5.29 m (17 ft. 4 in.)	1.42 m (4 ft. 8 in.)	0.82 m (32 in.)	4330 kg (9,546 lb.)
4.4 m (14 ft. 5 in.)	5.88 m (19 ft. 3 in.)	1.42 m (4 ft. 8 in.)	0.82 m (32 in.)	4660 kg (10,274 lb.)
5.4 m (17 ft. 9 in.)	6.83 m (22 ft. 5 in.)	1.48 m (4 ft. 10 in.)	0.80 m (31 in.)	4950 kg (10,913 lb.)
<b>Less Arm and Counterweight</b>	7.08 m (23 ft. 3 in.)	4.41 m (14 ft. 6 in.) / 3.39 m (11 ft. 1 in.) without exhaust stack	3.60 m (11 ft. 10 in.)	51 800 kg (114,199 lb.) with 650-mm (26 in.) shoes / 52 500 kg (115,743 lb.) with 750-mm (30 in.) shoes

\*Steps on the track frame and the side hydraulic oil tank, handrails on the upper battery box, upper fuel tank, and the side hydraulic oil tank must be removed to comply with the overall width dimensions above.

\*\*The dimensions and the weights indicate those of one side frame.

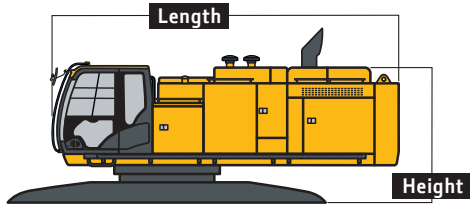

Base Machine

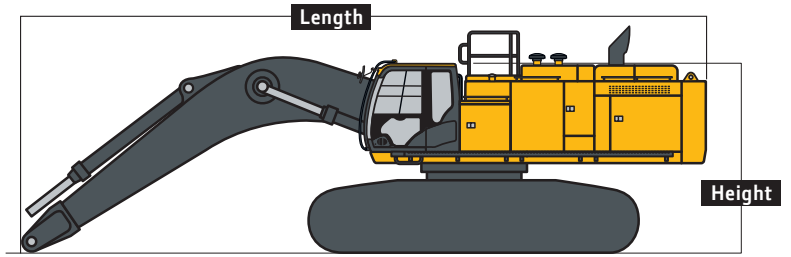

Less Counterweight and Arm

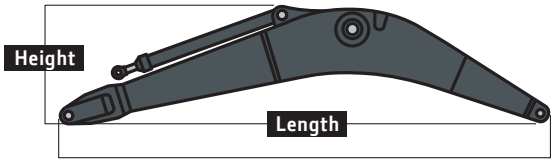

Boom

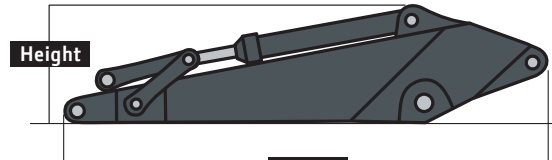

Arm

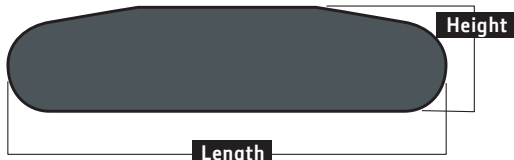

Side Frame

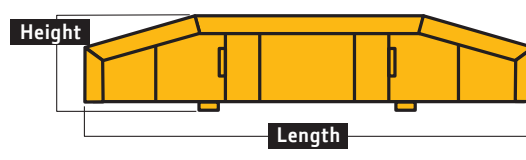

Counterweight

**Lift Capacities**

**Boldface type** indicates hydraulically limited capacity; lightface type indicates stability-limited capacities, in kg (lb.). Ratings at bucket lift hook; machine equipped with standard gauge and situated on firm, uniform supporting surface. Total load includes weight of cables, hook, etc. Figures do not exceed 87 percent of hydraulic capacities or 75 percent of weight needed to tip machine. All lift capacities are based on ISO 10567 (with power boost).

Load Point Height	3.0 m (10 ft.)		4.5 m (15 ft.)		6.0 m (20 ft.)		7.5 m (25 ft.)		9.0 m (30 ft.)		10.5 m (35 ft.)		12.0 m (40 ft.)	
Horizontal Distance from Centerline of Rotation	Over Front	Over Side	Over Front	Over Side	Over Front	Over Side	Over Front	Over Side	Over Front	Over Side	Over Front	Over Side	Over Front	Over Side
<i>With 2.9-m<sup>3</sup> (3.79 cu. yd.) bucket, 4.4-m (14 ft. 5 in.) arm, 8.4-m (27 ft. 7 in.) boom, and 650-mm (26 in.) double-bar grouser shoes</i>														
9.0 m (30 ft.)											10 017 (19,446)	10 017 (19,446)		
7.5 m (25 ft.)									13 533 (29,445)	13 533 (29,445)	12 668 (26,635)	12 546 (26,635)		
6.0 m (20 ft.)							16 971 (36,623)	16 971 (36,623)	14 840 (32,179)	14 840 (32,179)	13 489 (29,365)	12 255 (26,246)	9301 (16,454)	9288 (16,454)
4.5 m (15 ft.)			25 251 (54,124)	25 251 (54,124)	19 607 (42,254)	19 607 (42,254)	16 415 (35,518)	15 519 (33,378)	14 422 (31,321)	14 422 (31,321)	11 822 (25,362)	11 822 (25,362)	11 997 (23,411)	9110 (19,434)
3.0 m (10 ft.)			29 592 (63,589)	28 023 (60,425)	22 176 (47,813)	19 817 (42,693)	18 010 (38,942)	14 781 (31,795)	15 403 (33,396)	11 363 (24,389)	13 674 (27,728)	11 363 (24,389)	13 674 (27,728)	8875 (18,968)
1.5 m (5 ft.)			28 893 (69,872)	26 575 (57,214)	24 195 (52,236)	18 846 (40,574)	19 362 (41,869)	14 143 (30,416)	16 260 (35,217)	10 951 (23,508)	13 846 (29,651)	10 951 (23,508)	13 846 (29,651)	8631 (18,483)
Ground Line			28 793 (68,029)	25 831 (55,531)	25 383 (54,873)	18 201 (39,155)	20 259 (43,815)	13 672 (29,394)	16 821 (36,393)	10 634 (22,832)	13 656 (26,766)	10 634 (22,832)	13 656 (26,766)	8454 (18,128)
-1.5 m (-5 ft.)			16 350 (37,551)	16 350 (37,551)	33 262 (72,025)	25,555 (54,895)	25 660 (55,505)	17 863 (38,407)	20 543 (44,412)	13 394 (28,791)	16 806 (36,123)	10 449 (22,446)		
-3.0 m (-10 ft.)	16 528 (37,406)	16 528 (37,406)	24 952 (57,056)	24 952 (57,056)	31 886 (69,029)	25 594 (54,968)	24 981 (53,997)	17 787 (38,243)	20 048 (43,253)	13 315 (28,633)	16 234 (34,820)	10 432 (22,447)		
-4.5 m (-15 ft.)	25 416 (57,577)	25 416 (57,577)	36 206 (81,680)	36 206 (81,680)	29 279 (63,219)	25 896 (55,642)	23 165 (49,890)	17 955 (38,630)	18 445 (39,501)	13 459 (28,987)				
-6.0 m (-20 ft.)			31 730 (68,104)	31 730 (68,104)	24 964 (53,446)	24 964 (53,446)	19 636 (41,734)	18 414 (39,695)						

**Lift Capacities (continued) 870G LC**

**Boldface type** indicates hydraulically limited capacity; **lightface type** indicates stability-limited capacities, in kg (lb.). Ratings at bucket lift hook; machine equipped with standard gauge and situated on firm, uniform supporting surface. Total load includes weight of cables, hook, etc. Figures do not exceed 87 percent of hydraulic capacities or 75 percent of weight needed to tip machine. All lift capacities are based on ISO 10567 (with power boost).

Load Point Height	3.0 m (10 ft.)		4.5 m (15 ft.)		6.0 m (20 ft.)		7.5 m (25 ft.)		9.0 m (30 ft.)		10.5 m (35 ft.)		12.0 m (40 ft.)	
Horizontal Distance from Centerline of Rotation	Over Front	Over Side	Over Front	Over Side	Over Front	Over Side	Over Front	Over Side	Over Front	Over Side	Over Front	Over Side	Over Front	Over Side
<i>With 4.5-m<sup>3</sup> (5.89 cu. yd.) bucket, 2.95-m (9 ft. 8 in.) BE arm, 7.1-m (23 ft. 4 in.) BE boom, and 650-mm (26 in.) double-bar grouser shoes</i>														
7.5 m (25 ft.)							<b>18 586</b>	<b>18 586</b>						
							(40,535)	(40,535)						
6.0 m (20 ft.)					<b>24 030</b>	<b>24 030</b>	<b>20 180</b>	<b>20 180</b>	<b>17 955</b>	<b>15 295</b>				
					(51,762)	(51,762)	(43,741)	(43,741)	(39,197)	(32,640)				
4.5 m (15 ft.)					<b>28 171</b>	<b>28 171</b>	<b>22 238</b>	<b>20 727</b>	<b>18 941</b>	<b>14 949</b>				
					(60,565)	(60,565)	(48,083)	(44,569)	(41,121)	(32,000)				
3.0 m (10 ft.)					<b>31 893</b>	<b>28 423</b>	<b>24 273</b>	<b>19 742</b>	<b>19 970</b>	<b>14 436</b>				
					(68,676)	(61,194)	(52,446)	(42,457)	(43,285)	(30,974)				
1.5 m (5 ft.)					<b>33 940</b>	<b>27 185</b>	<b>25 677</b>	<b>18 944</b>	<b>20 662</b>	<b>13 961</b>				
					(73,303)	(58,454)	(55,503)	(40,722)	(44,705)	(29,963)				
Ground Line					<b>34 060</b>	<b>26 550</b>	<b>26,028</b>	<b>18 430</b>	<b>20 609</b>	<b>13 643</b>				
					(73,723)	(57,025)	(56,274)	(39,600)	(44,450)	(29,293)				
-1.5 m (-5 ft.)			<b>37 404</b>	<b>37 404</b>	<b>32 417</b>	<b>26 358</b>	<b>24 990</b>	<b>18 223</b>						
			(86,602)	(86,602)	(70,176)	(56,585)	(53,930)	(39,155)						
-3.0 m (-10 ft.)	<b>37 120</b>	<b>37 120</b>	<b>37 087</b>	<b>37 087</b>	<b>28 747</b>	<b>26 539</b>	<b>21 817</b>	<b>18 368</b>						
	(84,432)	(84,432)	(80,338)	(80,338)	(61,986)	(56,992)	(46,554)	(39,521)						
<i>With 2.9-m<sup>3</sup> (3.79 cu. yd.) bucket, 4.4-m (14 ft. 5 in.) arm, 8.4-m (27 ft. 7 in.) boom, and 750-mm (30 in.) double-bar grouser shoes</i>														
9.0 m (30 ft.)											<b>10 017</b>	<b>10 017</b>		
											(19,446)	(19,446)		
7.5 m (25 ft.)									<b>13 533</b>	<b>13 533</b>	<b>12 668</b>	<b>12 662</b>		
									(29,445)	(29,445)	(26,635)	(26,635)		
6.0 m (20 ft.)							<b>16 971</b>	<b>16 971</b>	<b>14 840</b>	<b>14 840</b>	<b>13 489</b>	<b>12 370</b>	<b>9301</b>	<b>9301</b>
							(36,623)	(36,623)	(32,179)	(32,179)	(29,365)	(26,496)	(16,454)	(16,454)
4.5 m (15 ft.)					<b>25 251</b>	<b>25 251</b>	<b>19 607</b>	<b>16 415</b>	<b>15 659</b>	<b>14 422</b>	<b>11 938</b>	<b>11 997</b>	<b>9209</b>	<b>9209</b>
					(54,124)	(54,124)	(42,254)	(42,254)	(35,518)	(33,681)	(31,321)	(25,612)	(23,411)	(19,647)
3.0 m (10 ft.)					<b>29 592</b>	<b>28 265</b>	<b>22 176</b>	<b>19 994</b>	<b>18 010</b>	<b>14 921</b>	<b>15 403</b>	<b>11 479</b>	<b>13 674</b>	<b>8974</b>
					(63,589)	(60,945)	(47,813)	(43,076)	(38,942)	(32,097)	(33,396)	(24,639)	(27,728)	(19,181)
1.5 m (5 ft.)					<b>28 893</b>	<b>26 816</b>	<b>24 195</b>	<b>19 023</b>	<b>19 362</b>	<b>14 283</b>	<b>16 260</b>	<b>11 066</b>	<b>13 991</b>	<b>8730</b>
					(69,872)	(57,734)	(52,236)	(40,957)	(41,869)	(30,718)	(35,217)	(23,758)	(29,651)	(18,697)
Ground Line					<b>28 793</b>	<b>26 072</b>	<b>25 383</b>	<b>18 378</b>	<b>20 259</b>	<b>13 812</b>	<b>16 821</b>	<b>10 750</b>	<b>13 801</b>	<b>8552</b>
					(68,029)	(56,051)	(54,873)	(39,537)	(43,815)	(29,696)	(36,393)	(23,082)	(26,766)	(18,341)
-1.5 m (-5 ft.)			<b>16 350</b>	<b>16 350</b>	<b>33 262</b>	<b>25 797</b>	<b>25 660</b>	<b>18 040</b>	<b>20 543</b>	<b>13 534</b>	<b>16 905</b>	<b>10 564</b>		
			(37,551)	(37,551)	(72,025)	(55,415)	(55,505)	(38,790)	(44,412)	(29,094)	(36,496)	(22,696)		
-3.0 m (-10 ft.)	<b>16 528</b>	<b>16 528</b>	<b>24 952</b>	<b>24 952</b>	<b>31 886</b>	<b>25 835</b>	<b>24 981</b>	<b>17 964</b>	<b>20 048</b>	<b>13 455</b>	<b>16 234</b>	<b>10 548</b>		
	(37,406)	(37,406)	(57,056)	(57,056)	(69,029)	(55,489)	(53,997)	(38,625)	(43,253)	(28,936)	(34,820)	(22,697)		
-4.5 m (-15 ft.)	<b>25 416</b>	<b>25 416</b>	<b>36 206</b>	<b>36 206</b>	<b>29 279</b>	<b>26 138</b>	<b>23 165</b>	<b>18 132</b>	<b>18 445</b>	<b>13 599</b>				
	(57,577)	(57,577)	(81,680)	(81,680)	(63,219)	(56,162)	(49,890)	(39,012)	(39,501)	(29,289)				
-6.0 m (-20 ft.)			<b>31 730</b>	<b>31 730</b>	<b>24 964</b>	<b>24 964</b>	<b>19 636</b>	<b>18 591</b>						
			(68,104)	(68,104)	(53,446)	(53,446)	(41,734)	(40,078)						
<i>With 3.5-m<sup>3</sup> (4.58 cu. yd.) bucket, 3.7-m (12 ft. 2 in.) arm, 8.4-m (27 ft. 7 in.) boom, and 900-mm (36 in.) double-bar grouser shoes</i>														
9.0 m (30 ft.)									<b>13 883</b>	<b>13 883</b>				
									(30,445)	(30,445)				
7.5 m (25 ft.)									<b>14 650</b>	<b>14 650</b>	<b>13 097</b>	<b>12 403</b>		
									(31,872)	(31,872)	(25,048)	(25,048)		
6.0 m (20 ft.)					<b>22 867</b>	<b>22 867</b>	<b>18 428</b>	<b>18 428</b>	<b>15 885</b>	<b>15 885</b>	<b>14 331</b>	<b>12 206</b>		
					(48,972)	(48,972)	(39,742)	(39,742)	(34,438)	(34,438)	(31,213)	(26,116)		
4.5 m (15 ft.)					<b>27 613</b>	<b>27 613</b>	<b>20 981</b>	<b>20 942</b>	<b>17 362</b>	<b>15 521</b>	<b>15 159</b>	<b>11 849</b>		
					(59,131)	(59,131)	(45,194)	(45,132)	(37,560)	(33,384)	(32,927)	(25,416)		
3.0 m (10 ft.)					<b>31 519</b>	<b>27 885</b>	<b>23 337</b>	<b>19 847</b>	<b>18 811</b>	<b>14 858</b>	<b>16 005</b>	<b>11 450</b>		
					(67,721)	(60,141)	(50,308)	(42,764)	(40,667)	(31,963)	(34,698)	(24,576)		
1.5 m (5 ft.)					<b>25 408</b>	<b>25 408</b>	<b>25 009</b>	<b>19 031</b>	<b>19 954</b>	<b>14 310</b>	<b>16 691</b>	<b>11 103</b>		
					(61,704)	(57,717)	(53,998)	(40,974)	(43,142)	(30,777)	(36,137)	(23,838)		
Ground Line					<b>29 583</b>	<b>26 386</b>	<b>25 770</b>	<b>18 542</b>	<b>20 579</b>	<b>13 934</b>	<b>17 019</b>	<b>10 858</b>		
					(69,892)	(56,704)	(55,722)	(39,887)	(44,499)	(29,959)	(36,789)	(23,320)		
-1.5 m (-5 ft.)			<b>18 560</b>	<b>18 560</b>	<b>32 751</b>	<b>26 313</b>	<b>25 587</b>	<b>18 338</b>	<b>20 522</b>	<b>13 749</b>	<b>16 753</b>	<b>10 755</b>		
			(42,711)	(42,711)	(70,992)	(56,510)	(55,356)	(39,429)	(44,342)	(29,561)	(36,067)	(23,121)		
-3.0 m (-10 ft.)	<b>20 695</b>	<b>20 695</b>	<b>30 186</b>	<b>30 186</b>	<b>30 768</b>	<b>26 486</b>	<b>24 398</b>	<b>18 375</b>	<b>19 560</b>	<b>13 767</b>				
	(46,802)	(46,802)	(69,025)	(69,025)	(66,644)	(56,882)	(52,716)	(39,513)	(42,114)	(29,620)				
-4.5 m (-15 ft.)			<b>34 430</b>	<b>34 430</b>	<b>27 474</b>	<b>26 903</b>	<b>21 900</b>	<b>18 657</b>	<b>17 089</b>	<b>14 047</b>				
			(74,510)	(74,510)	(59,278)	(57,812)	(47,044)	(40,158)	(36,205)	(30,306)				
-6.0 m (-20 ft.)			<b>27 445</b>	<b>27 445</b>	<b>22 087</b>	<b>22 087</b>	<b>16 999</b>	<b>16 999</b>						
			(58,692)	(58,692)	(46,986)	(46,986)	(35,451)	(35,451)						





**Lift Capacities (continued) 870G LC**

**Boldface type** indicates hydraulically limited capacity; lightface type indicates stability-limited capacities, in kg (lb.). Ratings at bucket lift hook; machine equipped with standard gauge and situated on firm, uniform supporting surface. Total load includes weight of cables, hook, etc. Figures do not exceed 87 percent of hydraulic capacities or 75 percent of weight needed to tip machine. All lift capacities are based on ISO 10567 (with power boost).

Load Point Height	3.0 m (10 ft.)		4.5 m (15 ft.)		6.0 m (20 ft.)		7.5 m (25 ft.)		9.0 m (30 ft.)		10.5 m (35 ft.)		12.0 m (40 ft.)									
	Over Front	Over Side	Over Front	Over Side	Over Front	Over Side	Over Front	Over Side	Over Front	Over Side	Over Front	Over Side	Over Front	Over Side								
<i>With 2.0-m³ (2.63 cu. yd.) bucket, 4.4-m (14 ft. 5 in.) arm, 10.0-m (32 ft. 10 in.) boom, and 900-mm (36 in.) double-bar grouser shoes</i>																						
9.0 m (30 ft.)												10 151	10 151	9756	9756							
												(22,132)	(22,132)	(21,446)	(21,283)							
7.5 m (25 ft.)												10 899	10 899	10 132	9810							
												(23,662)	(23,662)	(22,105)	(20,957)							
6.0 m (20 ft.)					16 521	16 521	13 630	13 630	11 858	11 858	10 724	9483										
					(35,416)	(35,416)	(29,377)	(29,377)	(25,670)	(25,670)	(23,319)	(20,312)										
4.5 m (15 ft.)					19 241	19 241	15 295	14 885	12 932	11 545	11 408	9083										
					(41,259)	(41,259)	(32,945)	(32,099)	(27,955)	(24,832)	(24,750)	(19,473)										
3.0 m (10 ft.)					21 599	18 293	16 856	13 987	13 985	10 947	12 110	8686										
					(46,412)	(39,516)	(36,327)	(30,155)	(30,219)	(23,547)	(26,236)	(18,631)										
1.5 m (5 ft.)					23 185	17 376	18 103	13 284	14 889	10 443	12 734	8338										
					(49,966)	(37,469)	(39,061)	(28,616)	(32,178)	(22,456)	(27,568)	(17,886)										
Ground Line					23 959	16 880	18 919	12 809	15 545	10 069	13 194	8070										
					(51,762)	(36,337)	(40,872)	(27,567)	(33,604)	(21,642)	(28,545)	(17,314)										
-1.5 m (-5 ft.)			13 348	13 348	24 068	16 677	19 267	12 546	15 876	9839	13 200	7905										
			(31,421)	(31,421)	(52,075)	(35,861)	(41,656)	(26,983)	(34,317)	(21,143)	(28,378)	(16,969)										
-3.0 m (-10 ft.)			11 968	11 968	20 969	20 969	23 609	16 679	19 127	12 468	15 807	9756	13 157	7865								
			(27,635)	(27,635)	(48,643)	(48,643)	(51,101)	(35,853)	(41,349)	(26,809)	(34,134)	(20,971)	(28,313)	(16,908)								
-4.5 m (-15 ft.)	15 257	15 257	20 145	20 145	27 964	24 512	22 563	16 854	18 433	12 559	15 212	9830	12 437	7999								
	(34,672)	(34,672)	(46,108)	(46,108)	(60,593)	(52,631)	(48,786)	(36,239)	(39,781)	(27,018)	(32,732)	(21,158)	(26,419)	(17,278)								
-6.0 m (-20 ft.)	23 304	23 304	29 883	29 883	25 525	25 021	20 774	17 210	16 994	12 835	13 757	10 112										
	(52,949)	(52,949)	(68,530)	(68,530)	(55,119)	(53,772)	(44,755)	(37,042)	(36,475)	(27,657)	(29,212)	(21,846)										
-7.5 m (-25 ft.)	26 926	26 926	21 895	21 895	17 842	17 809	14 240	13 388														
	(57,739)	(57,739)	(46,867)	(46,867)	(38,010)	(38,010)	(29,895)															
<i>With 1.9-m³ (2.48 cu. yd.) bucket, 5.4-m (17 ft. 9 in.) arm, 10.0-m (32 ft. 10 in.) boom, and 900-mm (36 in.) double-bar grouser shoes</i>																						
9.0 m (30 ft.)														8717	8717							
														(19,090)	(19,090)							
7.5 m (25 ft.)											9858	9858	9221	9221								
											(21,398)	(21,398)	(20,090)	(20,090)								
6.0 m (20 ft.)									12 358	12 358	10 883	10 883	9892	9883								
									(26,649)	(26,649)	(23,559)	(23,559)	(21,494)	(21,173)								
4.5 m (15 ft.)					17 395	17 395	14 090	14 090	12 034	12 029	10 666	9437										
					(37,340)	(37,340)	(30,365)	(30,365)	(26,017)	(25,866)	(23,130)	(20,232)										
3.0 m (10 ft.)					19 975	19 183	15 787	14 568	13 193	11 355	11 466	8984										
					(42,948)	(41,424)	(34,036)	(31,400)	(28,512)	(24,419)	(24,838)	(19,267)										
1.5 m (5 ft.)					21 992	17 948	17 249	13 708	14 242	10 756	12 211	8568										
					(47,391)	(38,713)	(37,224)	(29,529)	(30,782)	(23,125)	(26,435)	(18,377)										
Ground Line					23 285	17 153	18 341	13 069	15 081	10 278	12 822	8225										
					(22,849)	(36,945)	(40,435)	(28,131)	(39,622)	(22,091)	(32,606)	(17,641)										
-1.5 m (-5 ft.)			10 774	10 774	18 566	18 566	23 900	16 561	19 202	12 453	15 846	9761	13 146	7846								
			(24,721)	(24,721)	(42,934)	(42,934)	(51,712)	(35,613)	(41,521)	(26,778)	(34,245)	(20,975)	(28,263)	(16,843)								
-3.0 m (-10 ft.)	12 312	12 312	16 579	16 579	25 346	23 979	23 325	16 614	18 907	12 431	15 628	9730	13 057	7847								
	(27,934)	(27,934)	(37,876)	(37,876)	(58,533)	(51,509)	(50,442)	(35,729)	(40,845)	(26,738)	(33,711)	(20,922)	(28,068)	(16,876)								
-6.0 m (-20 ft.)	18 197	18 197	23 583	23 583	27 626	24 408	22 096	16 860	18 010	12 589	14 823	9866	12 050	8033								
	(41,299)	(41,299)	(53,952)	(53,952)	(59,688)	(52,460)	(47,677)	(36,283)	(38,788)	(27,105)	(31,805)	(21,255)	(25,492)	(17,363)								
-7.5 m (-25 ft.)	25 375	25 375	31 576	31 576	24 810	24 810	19 994	17 319	16 247	12 957	13 000	10 237										
	(57,797)	(57,797)	(67,916)	(67,916)	(53,324)	(53,324)	(42,882)	(37,325)	(34,683)	(27,960)	(27,337)	(22,163)										
-9.0 m (-30 ft.)			25 770	25 770	20 524	20 524	16 466	16 466	12 798	12 798												
			(54,676)	(54,676)	(43,483)	(43,483)	(34,644)	(34,644)	(26,223)	(26,223)												
<b>Buckets</b>																						
A full line of buckets is offered to meet a wide variety of applications. Digging forces are with power boost. Tooth selection includes the John Deere Fanggs™ Standard, Tiger, Twin Tiger, Abrasion panel, or Flare tooth. Replaceable cutting edges and a variety of teeth are available through John Deere Parts. Optional side cutters add 150 mm (6 in.) to bucket widths. Capacities are SAE heaped ratings.																						
Type Bucket	Bucket Width		Bucket Capacity		Bucket Weight		Bucket Dig Force (SAE)		Bucket Dig Force (ISO)		Arm Dig Force 4.4 m (14 ft. 5 in.) (SAE)		Arm Dig Force 4.4 m (14 ft. 5 in.) (ISO)		Arm Dig Force 5.4 m (17 ft. 9 in.) (SAE)		Arm Dig Force 5.4 m (17 ft. 9 in.) (ISO)		ME Arm Dig Force 2.95 m (9 ft. 8 in.) (SAE)			
	mm	in.	m³	cu. yd.	kg	lb.	kN	lb.	kN	lb.	kN	lb.	kN	lb.	kN	lb.	kN	lb.	kN	lb.	kN	lb.
Heavy Duty High Capacity	914	36	2.09	2.7	2767	6,100	360	80,973	369	82,855	264	59,251	270	60,770	230	51,673	236	52,981	361	81,247		
	1067	42	2.55	3.3	2972	6,552	360	80,973	369	82,855	264	59,251	270	60,770	230	51,673	236	52,981	361	81,247		
	1219	48	3.02	3.9	3177	7,004	360	80,973	369	82,855	264	59,251	270	60,770	230	51,673	236	52,981	361	81,247		
	1370	54	3.49	4.6	3558	7,844	360	80,973	369	82,855	264	59,251	270	60,770	230	51,673	236	52,981	361	81,247		
	1524	60	3.98	5.2	3572	7,875	360	80,973	369	82,855	264	59,251	270	60,770	230	51,673	236	52,981	361	81,247		
	1829	72	4.96	6.5	3786	8,346	360	80,973	369	82,855	264	59,251	270	60,770	230	51,673	236	52,981	361	81,247		
	2032	80	5.63	7.4	4519	9,963	360	80,973	369	82,855	264	59,251	270	60,770	230	51,673	236	52,981	361	81,247		
Heavy Capacity Dirt	2286	90	5.81	7.6	4296	9,471	341	76,746	379	85,298	268	60,338	275	61,885	275	61,782	307	69,050	370	83,150		
Heavy Duty	914	36	1.51	2.0	2510	5,534	372	83,647	414	92,967	276	62,098	283	63,691	300	67,336	335	75,259	384	86,270		
	1067	42	1.86	2.4	2761	6,087	372	83,647	414	92,967	276	62,098	283	63,691	300	67,336	335	75,259	384	86,270		
	1219	48	2.22	2.9	2935	6,471	372	83,647	414	92,967	276	62,098	283	63,691	300	67,336	335	75,259	384	86,270		
	1370	54	2.58	3.4	3091	6,814	372	83,647	414	92,967	276	62,098	283	63,691	300	67,336	335	75,259	384	86,270		
	1524	60	2.95	3.9	3232	7,125	372	83,647	414	92,967	276	62,098	283	63,691	300	67,336	335	75,259	384	86,270		
Truck Loading	2134	84	4.21	5.5	3285	7,242	363	81,638	404	90,735	274	61,607	281	63,186	238	53,456	244	54,809	380	85,393		
	2337	92	4.63	6.0	3598	7,932	363	81,638	404	90,735	274	61,607	281	63,186	238	53,456	244	54,809	380	85,393		

**Lift Capacities (continued) 870G LC**

**Boldface type** indicates hydraulically limited capacity; lightface type indicates stability-limited capacities, in kg (lb.). Ratings at bucket lift hook; machine equipped with standard gauge and situated on firm, uniform supporting surface. Total load includes weight of cables, hook, etc. Figures do not exceed 87 percent of hydraulic capacities or 75 percent of weight needed to tip machine. All lift capacities are based on ISO 10567 (with power boost).

Load Point Height	3.0 m (10 ft.)		4.5 m (15 ft.)		6.0 m (20 ft.)		7.5 m (25 ft.)		9.0 m (30 ft.)		10.5 m (35 ft.)		12.0 m (40 ft.)	
Horizontal Distance from Centerline of Rotation	Over Front	Over Side	Over Front	Over Side	Over Front	Over Side	Over Front	Over Side	Over Front	Over Side	Over Front	Over Side	Over Front	Over Side
With 2.0-m <sup>3</sup> (2.63 cu. yd.) bucket, 4-4-m (14 ft. 5 in.) arm, 10.0-m (32 ft. 10 in.) boom, and 1020-mm (40 in.) double-bar grouser shoes														
9.0 m (30 ft.)											10 151 (22,131)	10 151 (22,131)	9756 (21,445)	9756 (21,445)
7.5 m (25 ft.)											10 899 (23,662)	10 899 (23,662)	10 132 (22,105)	9922 (21,199)
6.0 m (20 ft.)							16 521 (35,416)	16 521 (35,416)	13 630 (29,377)	13 630 (29,377)	11 858 (25,670)	11 858 (25,670)	10 724 (23,319)	9595 (20,555)
4.5 m (15 ft.)							19 241 (41,259)	19 241 (41,259)	15 295 (32,945)	15 044 (32,443)	12 932 (27,955)	11 676 (25,116)	11 408 (24,750)	9195 (19,715)
3.0 m (10 ft.)							21 599 (46,412)	18 494 (39,951)	16 856 (36,327)	14 146 (30,499)	13 985 (30,219)	11 079 (23,832)	12 110 (26,236)	8798 (18,873)
1.5 m (5 ft.)							23 185 (49,966)	17 577 (37,903)	18 103 (39,061)	13 443 (28,959)	14 889 (32,178)	10 574 (22,740)	12 734 (27,568)	8450 (18,129)
Ground Line							23 959 (51,762)	17 081 (36,772)	18 919 (40,872)	12 968 (27,910)	15 545 (33,604)	10 200 (21,927)	13 194 (28,545)	8182 (17,556)
-1.5 m (-5 ft.)					13 350 (31,425)	13 350 (31,425)	24 068 (52,075)	16 878 (36,296)	19 267 (41,656)	12 705 (27,326)	15 876 (34,317)	9970 (21,427)	13 361 (28,727)	8017 (17,211)
-3.0 m (-10 ft.)			11 969 (27,636)	11 969 (27,636)	20 973 (48,661)	20 973 (48,661)	23 609 (51,101)	16 880 (36,288)	19 127 (41,349)	12 626 (27,152)	15 807 (34,134)	9887 (21,255)	13 242 (28,514)	7977 (17,151)
-4.5 m (-15 ft.)	15 257 (34,673)	15 257 (34,673)	20 145 (46,118)	20 145 (46,118)	27 964 (60,593)	24 787 (53,222)	22 563 (48,786)	17 055 (36,674)	18 433 (39,781)	12 717 (27,362)	15 212 (32,732)	9961 (21,442)	12 437 (26,419)	8111 (17,521)
-6.0 m (-20 ft.)	23 308 (52,949)	23 308 (52,949)	29 885 (68,516)	29 885 (68,516)	25 525 (55,119)	25 296 (54,363)	20 774 (44,755)	17 411 (37,477)	16 994 (36,475)	12 994 (28,000)	13 757 (29,212)	10 243 (22,130)		
-7.5 m (-25 ft.)			26 926 (57,739)	26 926 (57,739)	21 895 (46,867)	21 895 (46,867)	17 842 (38,010)	17 842 (38,010)	14 240 (29,895)	13 547 (29,319)				

**Bucket Selection Guide\***

	ME Arm Dig Force 2.95 m (9 ft. 8 in.) (ISO)		Bucket Tip Radius		Number of Teeth
	kN	lb.	mm	in.	
	377	84,686	2426	95.53	3
	377	84,686	2426	95.53	4
	377	84,686	2426	95.53	4
	377	84,686	2426	95.53	5
	377	84,686	2426	95.53	5
	377	84,686	2426	95.53	6
	377	84,686	2426	95.53	6
	386	86,669	2303	90.66	7
	400	89,922	2113	83.19	3
	400	89,922	2113	83.19	4
	400	89,922	2113	83.19	4
	400	89,922	2113	83.19	5
	400	89,922	2113	83.19	5
	396	89,008	2165	85.22	6
	396	89,008	2165	85.22	8

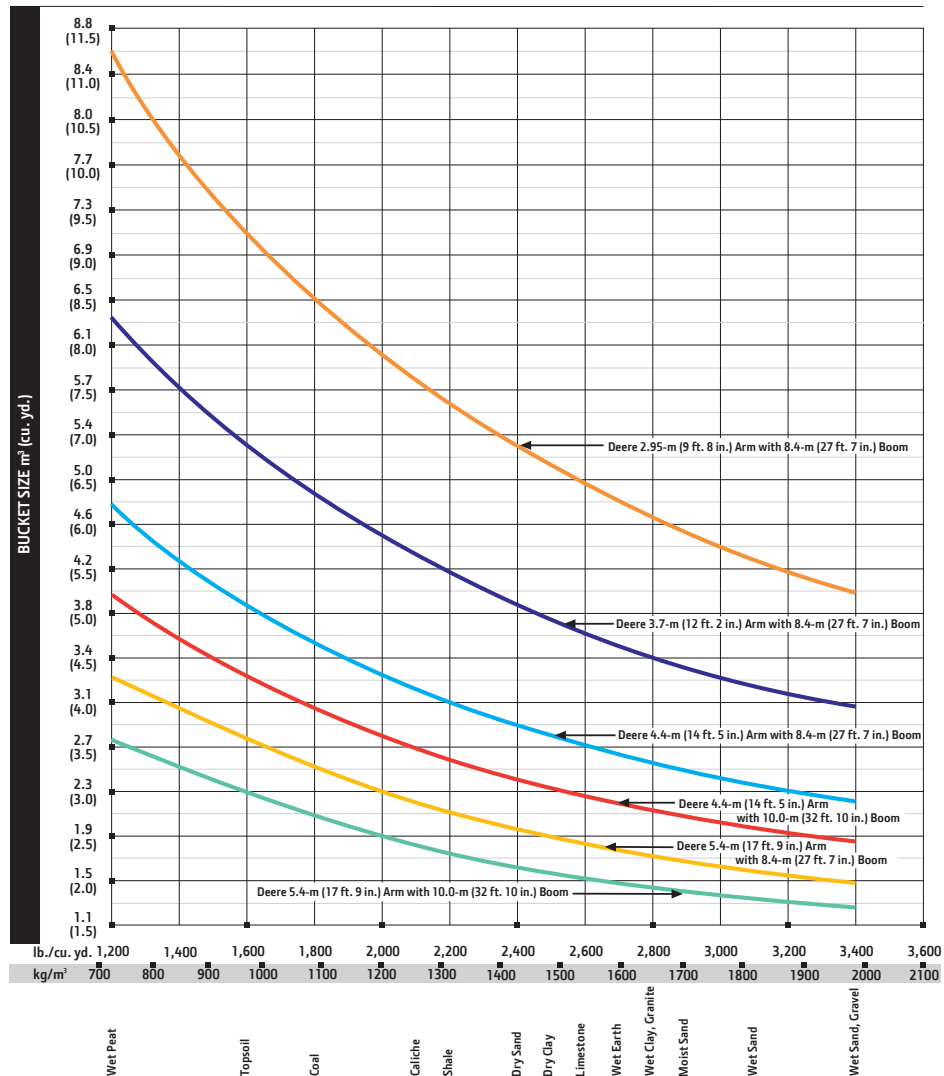

\* Contact your John Deere dealer for optimum bucket and attachment selections. These recommendations are for general conditions and average use. Does not include optional equipment such as thumbs or couplers. Larger buckets may be possible when using light materials, for flat and level operations, less compacted materials, and volume loading applications such as mass excavation applications in ideal conditions. Smaller buckets are recommended for adverse conditions such as off-level applications, rocks, and uneven surfaces. Bucket capacity indicated is SAE heaped.

# Additional equipment

Key: ● Standard ▲ Optional or special

See your John Deere dealer for further information.

670G	870G	Engine
●	●	Auto-idle system
●	●	Automatic belt-tension device
●	●	Batteries (2 – 12 volt)
●	●	Coolant recovery tank
●	●	Dual-element dry-type air filter
●	●	Electronic engine control
●	●	Enclosed fan guard (conforms to SAE J1308)
●	●	Engine coolant to –37 deg. C (–34 deg. F)
●	●	Fuel filter with water separator
●	●	Full-flow oil filter
●	●	Turbocharger with charge air cooler
●	●	Underhood exhaust after-treatment device with curved outlet
●	●	Muffler, under hood, with vertical curved end exhaust stack
●	●	Cool-on-demand hydraulic-driven fan
●	●	Glow-plug start aid
●	●	500-hour engine-oil-change interval
●	●	70% (35 deg.) off-level capability
●	●	Hydraulic fan reverser
		Hydraulic System
●	●	Reduced-drift valve for boom down, arm in
●	●	Auxiliary hydraulic valve section
●	●	Spring-applied, hydraulically released automatic swing brake
●	●	Auxiliary hydraulic-flow adjustments through monitor
●	●	Auto power lift
●	●	4,000-hour hydraulic-oil-change interval
▲	▲	Auxiliary pilot and electric controls
▲	▲	Hydraulic filter restriction indicator kit
▲	▲	Load-lowering control device
▲	▲	Single-pedal propel control
▲	▲	Pattern changer
		Undercarriage
●	●	Planetary drive with axial piston motors
●	●	Propel motor shields
●	●	Spring-applied, hydraulically released automatic propel brake
●	●	Track guides, front idler and center
●	●	2-speed propel with Autoshift
●	●	Upper carrier rollers (3)
●	●	Sealed and lubricated track chain
▲	▲	Double-bar grouser shoes, 650 mm (26 in.)
▲	▲	Double-bar grouser shoes, 750 mm (30 in.)
▲	▲	Double-bar grouser shoes, 900 mm (36 in.)
▲	▲	Double-bar grouser shoes, 1020 mm (40 in.)

670G	870G	Upperstructure
●	●	Right- and left-hand mirrors
●	●	Vandal locks with ignition key: Cab door / Fuel cap / Service doors / Toolbox
●	●	Debris screen in side panel
●	●	Service platform, left side
●	●	Remote-mounted engine oil and fuel filters
▲	▲	Counterweight-removal system
		Front Attachments
●	●	Centralized lubrication system
●	●	Dirt seals on all bucket pins
●	●	Lubricator with hose reel and grease gun
●	●	No-boom-arm option
▲	▲	Boom, 7.8 m (25 ft. 7 in.)
▲	▲	Boom, 8.4 m (27 ft. 7 in.)
▲	▲	Boom, mass excavating, 6.8 m (22 ft. 4 in.)
▲	▲	Boom, mass excavating, 7.1 m (23 ft. 4 in.)
▲	▲	Boom, reach, 10.0 m (32 ft. 10 in.)
▲	▲	Arm, mass excavating, 2.9 m (9 ft. 6 in.)
▲	▲	Arm, mass excavating, 2.95 m (9 ft. 8 in.)
▲	▲	Arm, 3.6 m (11 ft. 10 in.)
▲	▲	Arm, 3.7 m (12 ft. 2 in.)
▲	▲	Arm, 4.2 m (13 ft. 9 in.)
▲	▲	Arm, 4.4 m (14 ft. 5 in.)
▲	▲	Arm, 5.3 m (17 ft. 5 in.)
▲	▲	Arm, 5.4 m (17 ft. 9 in.)
▲	▲	Boom cylinder with plumbing to mainframe for no-boom-arm option
▲	▲	Buckets: Heavy duty / Heavy-duty high capacity / Side cutters and teeth
		Operator's Station
●	●	Adjustable independent-control positions (levers-to-seat, seat-to-pedals)
●	●	AM/FM radio
●	●	Auto climate control/air conditioner/heater/pressurizer, 5.9 kW (20,000 Btu/hr.)
●	●	Built-in Operator's Manual storage compartment and manual
●	●	Cell-phone power outlet, 12 volt, 60 watt, 5 amp
●	●	Coat hook
●	●	Deluxe air-suspension heated cloth seat with 100-mm (4 in.) adjustable armrests
●	●	Floor mat
●	●	Front windshield wiper with intermittent speeds
●	●	Gauges (illuminated): Engine coolant / Fuel
●	●	Horn, electric
●	●	Hourmeter, electric
●	●	Hydraulic shutoff lever, all controls

670G	870G	Operator's Station (continued)
●	●	Hydraulic warm-up control
●	●	Interior light
●	●	Large cup holder
●	●	Machine Information Center (MIC)
●	●	Mode selectors (illuminated): Power modes – 3 / Travel modes – 2 / Work mode – one for the 670G LC and 2 for the 870G LC / Boom mode
●	●	Multifunction, color LCD monitor with: Diagnostic capability / Multiple-language capabilities / Maintenance tracking / Clock / System monitoring with alarm features: Auto-idle indicator, engine air cleaner restriction indicator light, engine check, engine coolant temperature indicator light with audible alarm, engine oil pressure indicator light with audible alarm, low-alternator-charge indicator light, low-fuel indicator light, fault code alert indicator, fuel-rate display, wiper-mode indicator, work-lights-on indicator, and work-mode indicator
●	●	Fluid-level switch and indicator light for engine coolant and engine oil
●	●	Motion alarm with cancel switch (conforms to SAE J994)
●	●	Power-boost switch on right console lever
●	●	Propel pedals and levers
●	●	SAE 2-lever control pattern
●	●	Seat belt, 51 mm (2 in.), retractable
●	●	Tinted glass
●	●	Transparent tinted overhead hatch
●	●	Hot/cold beverage compartment
▲	▲	24- to 12-volt D.C. radio converters, 10 amp
▲	▲	Monitor system with alarm features: Hydraulic oil filter restriction indicator light
▲	▲	Protection screens for cab front, rear, and side
▲	▲	Seat belt, 76 mm (3 in.), non-retractable
▲	▲	Window vandal-protection covers
		Electrical
●	●	50-amp alternator
●	●	Blade-type multi-fused circuits
●	●	Positive-terminal battery covers
●	●	JDLINK™ wireless communication system
●	●	Rearview camera
▲	▲	Cab extension wiring harness
		Lights
●	●	Work lights: Halogen / 2 mounted on boom / One mounted on frame / 2 mounted on top of cab



Net engine power is with standard equipment including air cleaner, exhaust system, alternator, and cooling fan, at test conditions specified per ISO 9249. No derating is required up to 2000-m (6,560 ft.) altitude. Specifications and design subject to change without notice. Wherever applicable, specifications are in accordance with SAE standards. Except where otherwise noted, these specifications are based on units with 1370-mm (54 in.) buckets, 900-mm (36 in.) double-bar grouser shoes, full fuel tanks, and 79-kg (175 lb.) operators; a 670G LC unit with 10 400-kg (22,928 lb.) counterweight; and a 870G LC unit with 13 300-kg (29,321 lb.) counterweight.

www.JohnDeere.com