

0

0

8

T



KENWORTH.
The World's Best.





HIGH-VALUE • REAL-WORLD • SOLUTIONS

When you need a truck with the strength – and versatility – to tackle anything your business demands, settling for just anything in a truck won't get you where you want to go.

There was a time when customers scheduled deliveries by the calendar. Now they use a watch with an accurate second hand. Computers and satellite systems quicken the pace. Downtime is the enemy. And the competition keeps getting smarter. Welcome to the new millennium. • Needless to say, your buying criteria for heavy-duty trucks isn't what it used to be. Today, you need equipment that's easier to own and more affordable to operate. Equipment that will work harder, last longer and retain its value. Today, you need a more productive, more



profit-oriented, more reliable truck: Kenworth T800. • Kenworth's T800 is the ultimate workhorse – as much at home running freight coast to coast as it is delivering fuel across town or hauling gravel out of a quarry. Imagine the bottom-line advantages of a single base chassis that can do almost anything you ask of it. Plus, the T800 is built-to-take-it tough – proven very, very difficult to break. • Add the driver-side benefits of excellent maneuverability, operating efficiency and comfort ... and you've got not just a truck, but a whole new *solution*. • Kenworth T800. A high value – real world – solution.



**From the back alleys and boulevards of the big cities
to the vast stretches of asphalt that ribbon an American continent,
this is the one truck that can take it all in stride.**

Advanced technology and street-smart design – sloped hood, fuel-efficient drive train, aerodynamic options, unconventional maneuverability and high-style livability – make a T800 the perfect do-anything road warrior. • Available in 122.5 or 114-inch BBC, this responsive, smooth-riding conventional comes almost any way you want it. Spec it lean for payload-hungry applications – selecting from a multitude of weight-saving options. Dress it down in a no-frills day cab configuration for regional delivery. Or order it as a decked out thoroughbred with factory-installed, signature-setting Kenworth exclusives such as polished battery boxes, tool boxes and fuel tanks. Stainless cowl-mounted air cleaners. Dual polished vertical exhaust stacks. Lighted trim panels. Roof-mounted lamps and horns. You name it. • Inside, the T800 is pure Kenworth – ergonomically designed and filled with more driver-pleasing space, convenience features and luxury detail than you’ve ever imagined in a truck this productive. And check out the latest in Kenworth sleepers, sized to suit your job *and* lifestyle. Choose any Kenworth AeroCab model including our highly-prized Studio Sleeper.



Your T800 can be outfitted with heated, motorized aerodynamic mirrors to add style, while the foldaway design resists damage if struck.

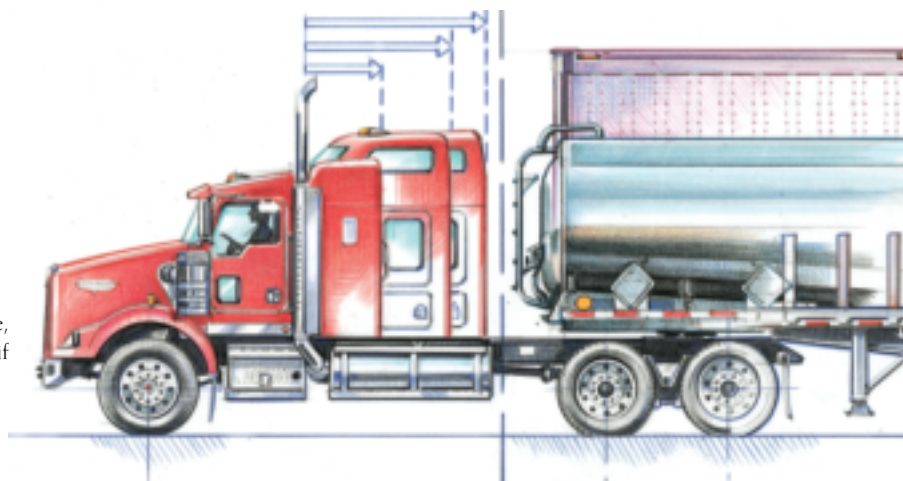

Select from a wide spectrum of Kenworth sleepers to enhance the application flexibility, comfort and lifestyle of your T800.

1. The T800 combines highway efficiency with on/off-road durability. This heavy equipment hauler features the 86" Studio Sleeper. ▶

2. This 72" AeroCab/Aerodyne is available with two bunks for linehaul teams.

3. Perfect for tanker applications, the T800 can be specified with a long list of weight-saving components without compromising reliability.

4. For hauling high center of gravity loads a strong stable frame is a must. The T800 offers variety of frame sizes and inserts custom designed to meet the most demanding requirements.

5. The 72" AeroCab/FlatTop sleeper is a terrific option for flatbed operations where overall height varies.

6. If you're hauling long loads, but still need a sleeper berth, Kenworth's 38" AeroCab delivers all the functionality without all the extra length.





As the heir to all the back-breaking experience Kenworths have withstood the world over, this is the perfect truck for imperfect conditions.

Maybe you need a truck with some serious backbone. Dump truck. Mixer. Lowboy. Logger. T800. • Kenworth knows how to build trucks that can shoulder maximum payload with minimum tare weight and move that burden with sure-footed confidence over steep, uneven and slippery job sites. That's why your T800 starts as a clean sheet of paper, its wheelbase custom tailored to your specifications. • Your design choices encompass the latest technologies and a spectrum of proven heavy-duty components for GCWs to 330,000 pounds. The highest horsepower engines. Radiators sized from 950 to 1520 square inches. Front axles up to 22,000 pounds. Twin steer front axles to 37,500 pounds. Front drive axles. Pusher axles and tags. Single, tandem and tridem drives. Every transmission option including auxiliaries. Rear and front engine PTOs. Dual power steering. Center front tow hitch. And a wide range of steel frame selections – with up to two inserts.

- All these options can be factory installed for a quality finished product that will move your business ahead the minute you put it to work.



Lift axles can be factory-installed, providing a fully-integrated solution where the braking system, lift controls and piping, the frame and even chassis components have all been designed with your final use in mind.

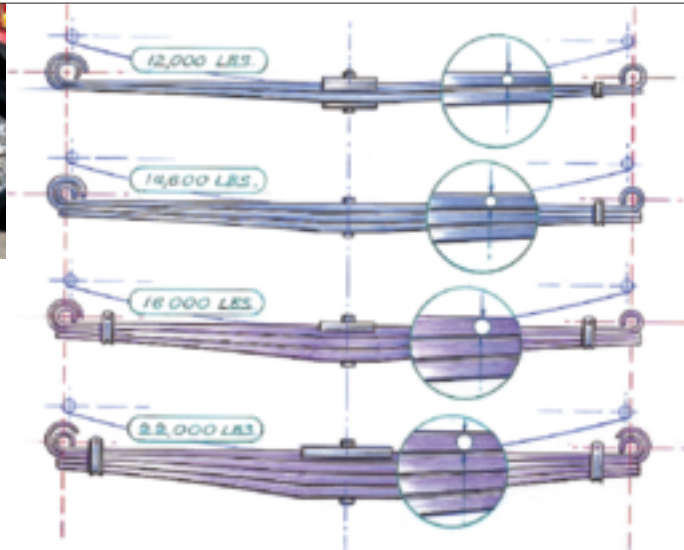

Kenworth's 59" long taperleaf front springs with shock absorbers offer a smooth ride with excellent stability. Available on the T800 in a wide range of ratings: from 12,000 lb. to 22,000 lb. Lightweight composite springs are also available for added payload.



A T800 can be specified with engine-mounted or traditional-looking cowl-mounted air cleaners. Your choice.

1. Kenworth brings style to any application. Select from a spectrum of custom-tailored trim and paint options.
2. For transfer dump operations the T800 is a perfect choice. It has one of the tightest turning radiuses of any truck and offers many weight-saving options to help boost usable payload.
3. DayLite® Doors and a one-piece curved windshield improves visibility.
4. The T800 is the truck of choice for tough logging applications.
5. Available in several hood options, a high-hood T800 combines traditional good looks with the excellent maneuverability of a setback front axle.
6. When it comes to pulling the biggest loads, you want a Kenworth. The T800 offers a 1,520 square inch radiator to cool the highest horsepower engines – even under the most demanding conditions.



1



2



3



4



5



6



Nothing says “We appreciate the job you’re doing” more than the ignition keys to a Kenworth.

It's easy to understand why so many professionals would rather go to work in a Kenworth than any other truck on the road. From floor mat to headliner, the T800 has been ergonomically fashioned for comfort, productivity and precise control. • The latest T800 cab features plenty of leg room – belly, knee and elbow room, too. Plus it's quieter than its predecessor – by about 20 percent. The state-of-the-art dash utilizes multiplexed electronic instrumentation and large, easy-to-reach switches and controls. The back-lit glare-free gauges with quick-to-read graphics. And the center console with two 12-volt outlets and a perfect place to store your cell phone, cups and soft drinks. • Then there are all the subtle things you can't see – you simply have to experience them. Like Kenworth's high performance heater/air conditioner with the motor thoughtfully mounted on the firewall to minimize cab noise. The flatter toe board angle and suspended throttle and clutch pedals that reduce leg strain. And the perfect fit and finish of Kenworth craftsmanship.



Getting in and out of a T800 is easy. With big, wide-opening doors, ergonomically positioned traction-grip steps and generous grab handles, cab access feels just right.



Air Cushion Premium Plus seats – orthopedically sculpted, fully adjustable for lateral and lumbar support, reclinable and available with arm rests – smooth out the rough spots.



With your needs in mind, the center console now features two 12-volt outlets and is a perfect place to store items such as cell phone, cups or soft drinks.



Available in Diamond (right) and Splendor (above) upholstery, Kenworth's new door pad presents a soft, durable, low-gloss luxurious finish you might associate with the finest automobiles. The new door pad design positions the window, door lock and mirror controls for easy touch access.





Extended Cab/Splendor Interior



Diamond VIT Cab



Diamond/Diamond VIT Dash



Splendor Dash



If you're looking for ways to work smarter – and more profitably – look no further.

More Payload: The T800, with its 48.5-inch set-back front axle, enables you to transfer more of the vehicle's weight to the front end – taking full advantage of its rated capacity. Any weight you can legally shift to the front axle, you can profitably add to payload – each and every truckload. • More Agility: The T800 incorporates advanced steering geometry that produces maximum wheel cut and a tight turning circle – even with flotation-type tires and front drive axle configurations. That advantage, plus a dramatically sloped hood and strategically placed, generously sized windows can increase driver confidence in tight situations. • More Control: Kenworth applies sophisticated ergonomic principles and state-of-the-art technologies to create trucks that are easier and safer to drive. Multi-function steering wheel, clutchless automated and automatic transmissions, multiplexed instrumentation and wireless communication systems all contribute to less fatiguing, more productive operation.

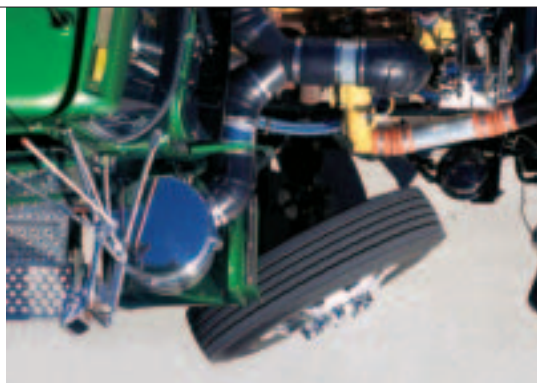

The T800's set-back front axle – together with steering geometry that delivers up to 54 degrees of wheel cut – helps drivers optimize and maneuver loads with ease.



A sloped hood gives the driver a much better view – offering more in-front-of-the-truck visibility than straight hood conventionals.



Optional cab corner windows help drivers who need to see better in reverse, at intersections and around the job site.

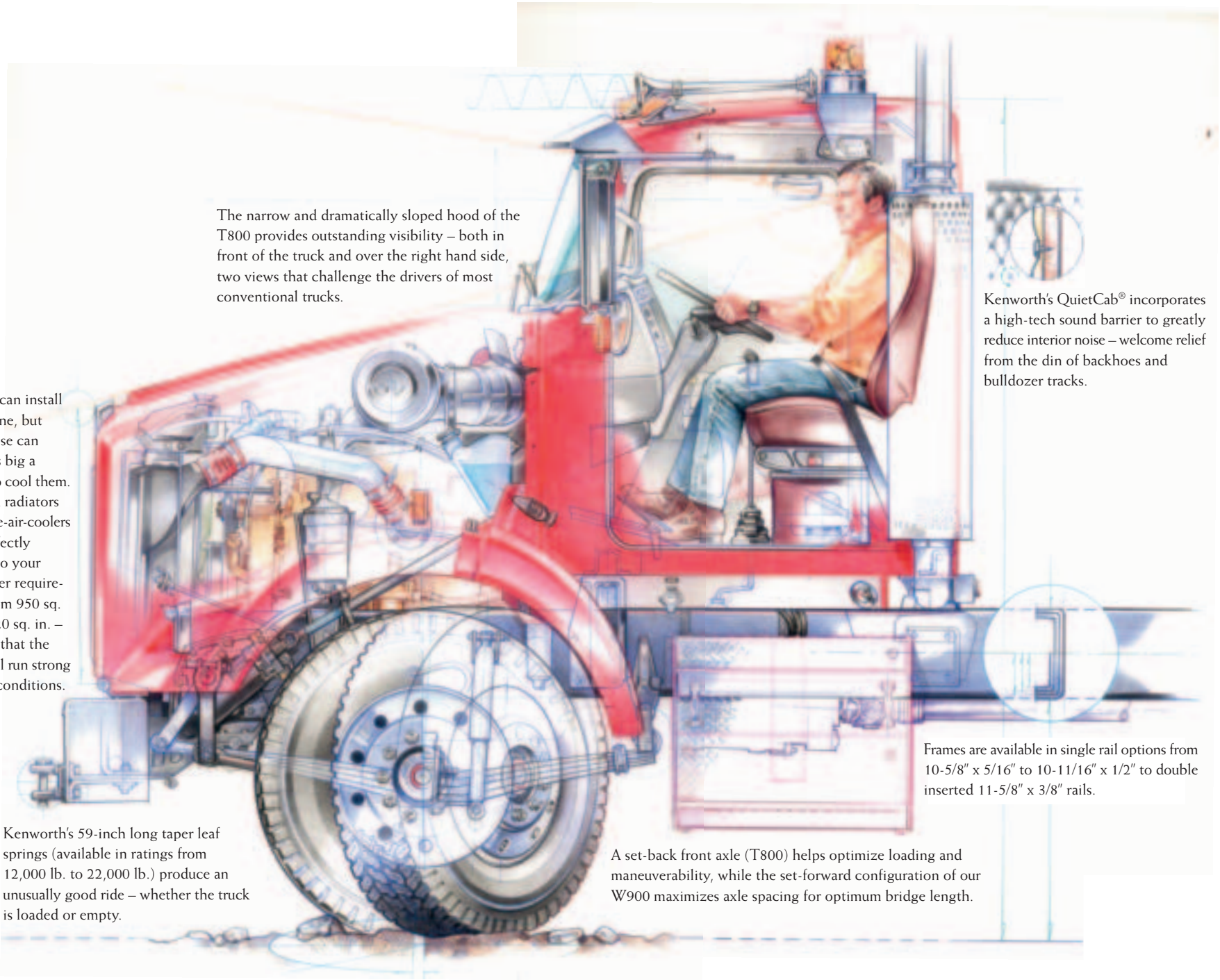

The narrow and dramatically sloped hood of the T800 provides outstanding visibility – both in front of the truck and over the right hand side, two views that challenge the drivers of most conventional trucks.

Anybody can install a big engine, but nobody else can provide as big a radiator to cool them. Kenworth radiators and charge-air-coolers come perfectly matched to your horsepower requirements, from 950 sq. in. to 1,520 sq. in. – insurance that the engine will run strong under all conditions.

Kenworth's 59-inch long taper leaf springs (available in ratings from 12,000 lb. to 22,000 lb.) produce an unusually good ride – whether the truck is loaded or empty.

Kenworth's QuietCab® incorporates a high-tech sound barrier to greatly reduce interior noise – welcome relief from the din of backhoes and bulldozer tracks.

Frames are available in single rail options from 10-5/8" x 5/16" to 10-11/16" x 1/2" to double inserted 11-5/8" x 3/8" rails.

A set-back front axle (T800) helps optimize loading and maneuverability, while the set-forward configuration of our W900 maximizes axle spacing for optimum bridge length.



In a world that tends to relax standards in pursuit of something new, the T800 proves that traditional, time-proven ways have their contemporary application.

From day one, Kenworth has engineered strong, lightweight trucks you can count on. Trucks with an unmatched ability to stay together, do the job, cost less to maintain and pay back their investments. • Just slam the door on a 10-year-old T800 mixer to see what we mean. Chances are it feels as solid as the day the truck left the factory. Legendary for its longevity and integrity, Kenworth's conventional cab combines aluminum and fiberglass in a Huckbolted assembly that's practically corrosion-proof and rattle-free. • Then there are all the little things you might not notice that help keep big things from going wrong. Wiring and plumbing bundled together and mounted high in the frame, safe from chafing, road salts or washing acids. Rubber-bushed shackle pins and bushings to extend suspension life and improve steering. Constant torque hose clamps. Radiator tie rods mounted to frame – not the cab – for longer radiator life. And so much more. • It's this kind of attention to detail that keeps you moving ahead. Day in, day out.

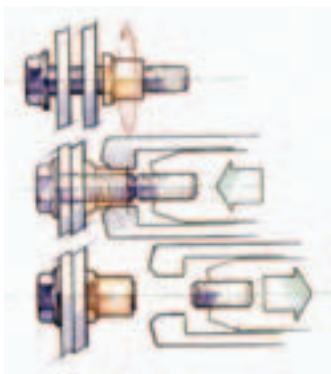

Huckbolts hold with six times the clamping force of normal rivets, resulting in a cab that's strong, durable and more rattle-free.



Thick bulkhead-type doors hang on continuous stainless steel piano hinges – not typical automotive hinges – and fit snugly to become an integral part of the cab structure – another reason Kenworth trucks bring more at resale than just about any other make you can name.

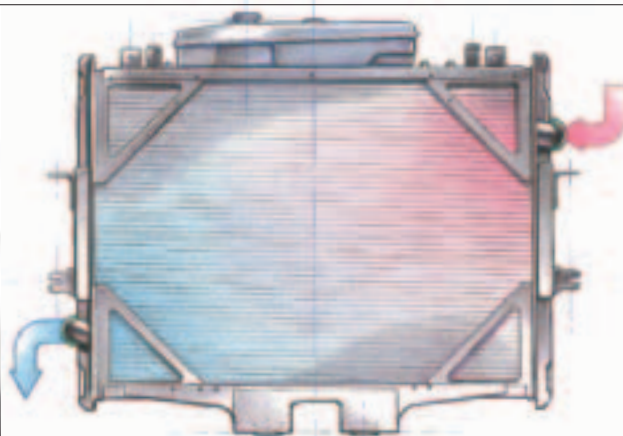

Kenworth's 1,520 sq. in. cross-flow radiator can cool today's high horsepower engines – even running full power at low speeds hauling heavy loads, a condition that would smoke a standard highway tractor.



Heavy-duty crossmembers and 3-hole gussets strengthen a T800's backbone, preparing it for the pounding your job dishes out. They can be replaced in less than 10 minutes with no special tools.





SERVICEABILITY

When it comes to maintenance on a T800, Kenworth's philosophy can be summed up in three words: easier and faster.

Tip the hood to see what we mean (inner fenders tilt out of the way at the same time). The engine sits high in the frame and totally ahead of the cab for complete access. You can check fluid levels and change fuel, oil and water filters while standing on the ground – not on a tire. The heater/air conditioner motor, electrical master connectors, windshield wiper motor and washer reservoir are all on the firewall, easier to repair. • Now take a close look at the engine cooling system. On a T800, it incorporates straight sections of reinforced rubber hose that are more readily available and much less expensive to replace than preformed hoses, along with steel elbows that are good for a lifetime of service. • Even the electrical system – a maintenance headache for most operators – has been designed for durability and streamlined troubleshooting. Multiplex instrumentation greatly simplifies cab wiring which is further color-coded and numbered for easy circuit tracing. • Quick-to-fix engineering features like these can mean a lot less downtime, shop time and money out of your pocket.



The T800's power distribution box puts all circuit protection elements – fuses, relays and breakers – in one quick-to-reach location.

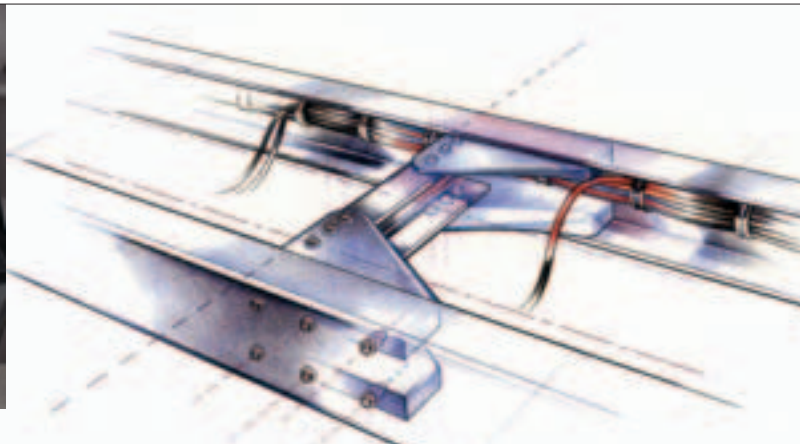

Kenworth's frame is a continuous straight rail constructed of heat-treated steel – custom-drilled to specification – offering superior strength and longevity. Extruded aluminum crossmembers and aluminum gussets – in standard designs for easy replacement – add additional foundation without adding a lot of extra weight. And all the components are free-fit fastened for extended life. Notice how Kenworth mounts all air and electrical lines high in the frame, away from potential sources of heat, caustic chemicals and mechanical abrasion.



Here is another reason Kenworths are so dependable: 12-volt maintenance-free batteries, held firmly in place and mounted on the left-hand side, close to the starter motor for minimum voltage drop.



Somewhere between shipping and receiving there's a whole lot of time in a truck. Hope it's a Kenworth.

Whether you choose a workhorse-rugged, yet way-above standard Splendor interior or the custom look of a Diamond upholstery package, the inside of a Kenworth has been designed to help those behind the wheel operate at their absolute best. Perform at peak efficiency. And rest in an environment that brings them closer to home. • Tour a Kenworth Studio Sleeper, or one of our AeroCab sleepers. Note the consummate balance between business and pleasure. The thoughtful, convenient and productive layout. The creative and elegant interior appointments. All handcrafted to the same exacting standard we use to build the rest of your Kenworth T800. • Then imagine the pride you'd feel knowing you've been given the keys to The World's Best truck. That sense of pride is one of the reasons Kenworth trucks last longer, work harder and bring more at trade-in. And one of the reasons Kenworth operators keep their best drivers.

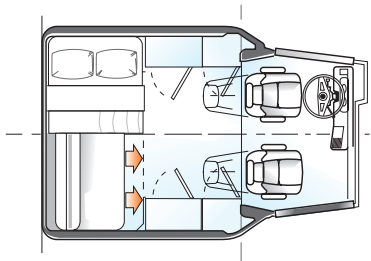

The floor plan of a Studio Sleeper gives you more seat adjustment – and reclining area. More elbow, leg and belly room. More room everywhere to stand up, stretch out and relax in style.



Wide non-slip thresholds will help keep your cab cleaner, while under the plush carpet or mat you get Kenworth's QuietCab® insulation for an exceptionally quiet ride.



86" Studio AeroCab®/Diamond VIT: ◀▶

Kenworth's 86" Studio AeroCab represents one of the most spacious and luxurious off-duty environments ever offered as original equipment by a truck manufacturer. With over seven feet of headroom, flush walk-through sleeper sill and space-conserving design features, the Studio AeroCab effectively doubles your living area compared to a conventional floor plan. Tinted picture windows, skylights and vented upper side windows further expand your sense of space as they bathe the interior in natural light. What a way to go!





72" AeroCab®/AERODYNE®/Diamond VIT:

The Kenworth AeroCab AERODYNE with a Diamond VIT interior is truly something special, offering plenty of headroom, space and light in a floor plan plus a myriad of extra-comfort features. Included are a deeply-tufted Diamond interior, full-length door-enclosed hanging closet, cabinet with two shelves, QuietCab® package, fold-down desk, over-bunk side storage compartments and a 42-inch mattress. Options include a fold-out sofa bed, side and rear picture windows, a TV mounting package, drawered cabinets, under-bunk drawers, liftable lower bunk, and a large-capacity front-loading refrigerator/freezer.

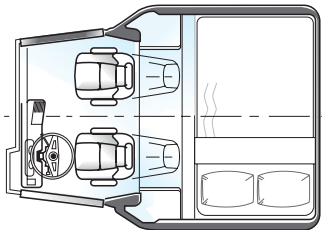
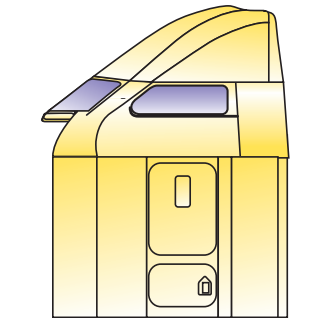



72" AeroCab®/AERODYNE®/Splendor:

Kenworth's "standard" Splendor interior has always been a cut above the Class 8 standard. But in an AeroCab, it's even further ahead. Included in the 72-inch model are a full-length clothes closet, storage shelves, insulated rubber floor mats, vented access doors and 42-inch mattress. A wide variety of options are available, including a folding upper bunk, under-bunk drawers, QuietCab package, TV installation kit, nylon carpet – even a liftable lower bunk with 42-inch mattress.

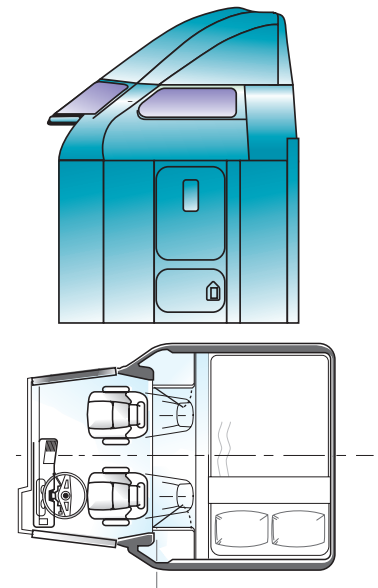



It's a real bonus when your truck can be made to fit this good.

Like those old work boots you've worn for so many long days they feel like part of your feet, your T800 comes formed to fit your lifestyle requirements. Precisely. • In fact, Kenworth still builds all its own sleepers, so you can be assured that the living environment receives the same painstaking attention to detail you'll find in the business end of your truck.

1. In Studio Sleeper and Aerodyne models, vista windows contribute natural light to your penthouse-like living environment.
2. The CB radio has its own compartment that provides for easy access and removal.
3. A liftable sofa bed provides easy inside access to storage for tools, extra clothes and other accessories you need to improve life on the road.
4. A high-capacity, front-loading refrigerator/freezer can be located for convenient access from cab or sleeper.
5. You even have a handy spot to file your log book.
6. Lighting throughout the cab and sleeper combines to brighten virtually every corner.



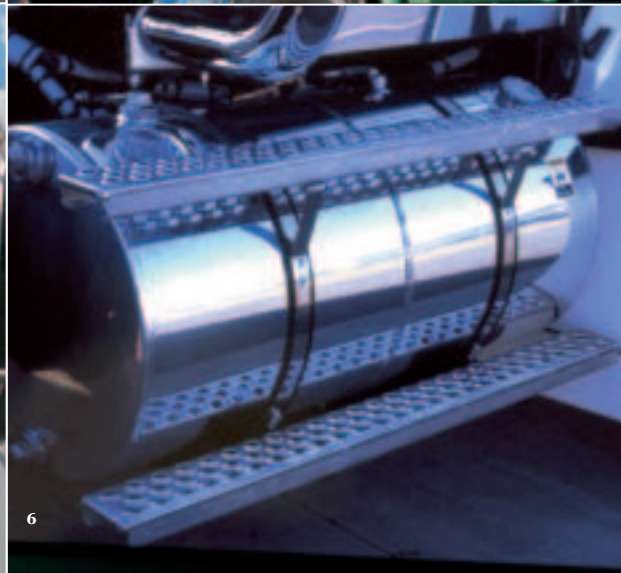

OPTIONS

As a custom truck builder, Kenworth offers more job-specific and factory-installed options than any other manufacturer.

The result is an integrated, fully-engineered, job-ready solution you can depend on – right from the start. • For hauling maximum legal loads without sacrificing strength and durability, you can select from a long list of weight-saving components and options including aluminum hubs, lightweight drums, aluminum clutch housing, aluminum bumper, lightweight charging/starting systems, composite leaf springs and more.

1. Kenworth's extended daycab offers more head, leg and belly room than a standard T800 daycab, plus extra storage space and reclinable seating – all with just a slight increase in tare weight.
2. How about a fiberglass sunvisor with a polished stainless steel insert? With integral marker lights, it's a terrific – and practical – addition to your T800.
3. A heavy duty cast center tow hook provides a robust attachment point for severe service applications.
4. Kenworth offers cowl-mounted stainless steel air cleaners from Donaldson.
5. A new cowl design provides greater specification flexibility – offering flat and curved glass windshields with Extended Day Cab and AeroCab sleeper options.
6. Kenworth-built hydraulic tanks match Kenworth-built fuel tanks for exceptional performance, durability and style. When frame space or weight requirements don't allow a separate tank, optional split fuel/hydraulic tanks are available (as shown).



You've been around long enough to know that even the best truck is only as good as the quality and commitment of the people who stand behind it.

T rue whether you're running across the country or across town. The reliability and money-making potential of your business relies a lot on the dependability of your support system. And that comes down to counting on people to have *your* best interests in mind. Because no matter how you figure it, the time your truck spends in the service bay costs you productive time on the job. • That's why it makes so much sense to rely on your Kenworth PremierCare® dealer for the parts, service and support you need. As a Kenworth PremierCare member, you've got priority access to the experts at our 24/7 KW-ASSIST hotline. People dedicated to keep you running nonstop. People you can trust to stand behind their work. People who appreciate, perhaps better than most, that you're not in business to merely own trucks, but to profit from them.



1-800-KW-ASSIST: No matter where you are in the United States and Canada – or when – you can count on the Kenworth PremierCare toll-free hotline to help you as quickly as possible.



The Customer Center representative that answers your call asks for the basics – your location and the VIN number. This is all logged into a computer database so that anyone in the Kenworth PremierCare Customer Center can assist in the call and track its status.

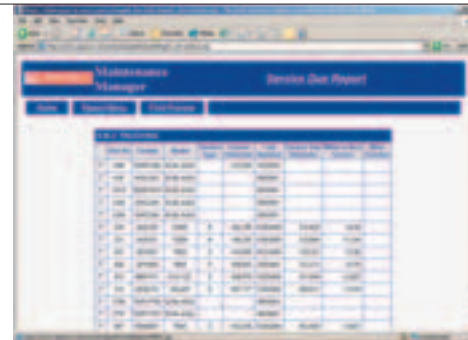

Kenworth PremierCare Preventive Maintenance: Tailored to fit the way you operate, this PM program – equivalent to just a few cents a mile – incorporates factory recommended procedures, annual government safety inspections and the common sense judgment of truck experts to optimize truck performance.

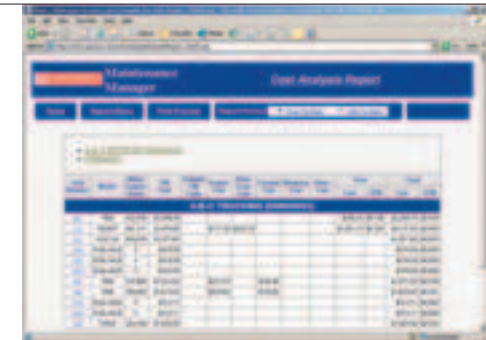















Kenworth PremierCare Maintenance Manager: PremierCare Maintenance Manager gives you a powerful new way to manage your maintenance expenses and control costs – whether you run one truck or 100.

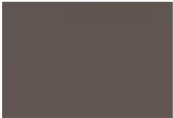

PremierCare
ExpressLube

Interior Color Options

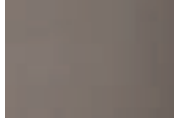
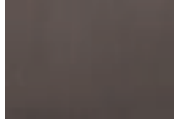
Choose your trim level and interior color in four easy steps.

<p>STEP 1 Choose Your Interior Trim Level</p> <p><input type="checkbox"/> DIAMOND, DIAMOND VIT (BURL WOOD)</p>  <p><input type="checkbox"/> SPLENDOR (BLACK)</p> 	<p>STEP 2 Choose Your Interior Color and Two Tone Seat Color</p> <p><input type="checkbox"/> SLATE GRAY</p>  <p><input type="checkbox"/> STEEL BLUE</p>  <p><input type="checkbox"/> BORDEAUX RED</p>  <p><input type="checkbox"/> JET BLACK</p> 	<p>STEP 3 Choose Your Seat Covering Material</p> <p><input type="checkbox"/> VINYL</p>  <p><input type="checkbox"/> VELOUR</p>  <p><input type="checkbox"/> MODURA</p>  <p><input type="checkbox"/> LEATHER</p> 	<p>STEP 4 Choose Your Floor Covering</p> <p><input type="checkbox"/> GRAY CARPET</p>  <p><input type="checkbox"/> BLACK CARPET</p>  <p><input type="checkbox"/> RUBBER MAT</p> 	<p>Dash, Lining and Cabinet Colors for All Interior Colors</p> <p><input type="checkbox"/> LIGHT SLATE GRAY</p>  <p><input type="checkbox"/> DARK SLATE GRAY</p>  <p>Optional Seat Colors</p> <p><input type="checkbox"/> JET BLACK TWO TONE</p>  <p><input type="checkbox"/> ALL JET BLACK</p> 
--	--	---	---	---

Leather Available Only in Gray, Jet Black and All Jet Black.

Style Amenities

	Splendor	Diamond	Diamond/VIT		Splendor	Diamond	Diamond/VIT
CAB				SLEEPER			
Smooth upholstered side & back panels	●			Full vinyl headliner	●		
Upholstered door pads & carpeted kick panel	●			Rolled & pleated upholstered wall panels & sleeper door pads	●		
Full vinyl headliner	●			Full Diamond-tufted vinyl headliner		●	●
Instrument panel with black trim	●	●	●	Diamond-tufted upholstered door pads & wall panels		●	●
Diamond-tufted upholstered side and back panels		●	●	Button color matches primary lining color		●	●
Diamond-upholstered door pads & carpeted kick panels		●	●	Two utility lights in tool compartment		●	●
Full Diamond-tufted vinyl headliner		●	●	Fold-down table			●
Diamond button colors matches primary lining color		●	●	Right-hand sleeper emergency exit door	●	●	●
Instrument panel with wood grain trim		●	●	Sleeper curtain	●	●	●
Black rubber floor mat	●	●	●	Black rubber floor mat in sleeper	●	●	●
Driver & rider side inside sunvisors	●	●	●	Open shelving and handling closets	●	●	
Door map pockets	●	●	●	Drawers and closet doors			●
DayLite® Doors	●	●	●	Accessory power outlet		●	●
Accessory power outlets in center console	●	●	●	Digital clock in sleeper		●	●
Under-dash floor lighting with red lens	●	●	●	Under-bunk storage	●	●	●
Left and right dome lamps mounted above doors	●	●	●				

Note: Photography and illustrations in this brochure may depict optional equipment. Equipment and specifications shown in this brochure are subject to change without notice. Consult with your Kenworth dealer at time of ordering for standard and optional equipment.



A DIVISION OF PACCAR

KENWORTH TRUCK COMPANY
P.O. Box 1000
Kirkland, Washington 98083-1000
(425) 828-5000

CANADIAN KENWORTH COMPANY
6711 Mississauga Road N.
Mississauga, Ontario L5N 4J8
(905) 858-7000

