

330D L

Hydraulic Excavator



Engine

Engine Model	Cat® C9 with ACERT™ Technology	
Net Flywheel Power	200 kW	268 hp

Weights

Operating Weight	36 151 kg	79,700 lb
------------------	-----------	-----------

- Reach boom, R3.9DB (12 ft 6 in) Stick, 1.19 m³ (1.56 yd³) GP Bucket, 800 mm (32 in) Shoe

330D L Hydraulic Excavator

The D Series incorporates innovations for improved performance and versatility.

C9 with ACERT™ Technology

- ✓ ACERT™ Technology works at the point of combustion to optimize engine performance and provide low exhaust emissions to meet U.S. EPA Tier 3 emission regulations, with exceptional performance capabilities and proven reliability. **pg. 4**

Hydraulics

The hydraulic system has been designed to provide reliability and outstanding controllability. An optional Tool Control System provides enhanced flexibility. **pg. 5**

Operator Station

- ✓ Provides maximum space, wider visibility and easy access to switches. The monitor is a full-color graphical display that allows the operator to understand the machine information easily. Overall, the new cab provides a comfortable environment for the operator. **pg. 6**

Versatility

Caterpillar offers a wide variety of factory-installed attachments that enhance performance and job site management. **pg. 11**

Service and Maintenance

Fast, easy service has been designed in with extended service intervals, advanced filtration, convenient filter access and user-friendly electronic diagnostics for increased productivity and reduced maintenance costs. **pg. 12**



Structures

Caterpillar® design and manufacturing techniques assure outstanding durability and service life from these important components. **pg. 8**

Booms, Sticks and Attachments

Built for good performance and long service life, Caterpillar® booms and sticks are large, welded, stress relieved, box-section structures with thick, multi-plate fabrications to resist high stress. The bucket linkage pins have been enlarged to improve reliability and durability. **pg. 9**

Work Tools – Attachments

- ✓ A variety of work tools, including buckets, couplers, hammers, and shears are available through Cat Work Tools. **pg. 10**

Complete Customer Support

Your Cat® dealer offers a wide range of services that can be set up under a customer support agreement when you purchase your equipment. The dealer will help you choose a plan that can cover everything from machine configuration to eventual replacement. **pg. 13**



✓ *New Feature*

C9 with ACERT™ Technology

The Cat® C9 gives the 330D L exceptional power and fuel efficiency unmatched in the industry for consistently high performance in all applications.



Cat C9. The Cat C9 with ACERT™ Technology introduces a series of evolutionary, incremental improvements that provide breakthrough engine technology. The building blocks of ACERT Technology are fuel delivery, air management and electronic control. ACERT Technology optimizes engine performance while meeting U.S. EPA Tier 3 engine emission regulations for off-road applications.

Performance. The 330D L, equipped with the C9 engine with ACERT™ Technology, provides 9% more horsepower as compared to the C9 in the 330C L.

Automatic Engine Speed Control.

The two-stage, one-touch control maximizes fuel efficiency and reduces sound levels.

ADEM™ A4 Engine Controller.

The ADEM A4 electronic control module manages fuel delivery to get the best performance per liter of fuel used. The engine management system provides flexible fuel mapping, allowing the engine to respond quickly to varying application needs. It tracks engine and machine conditions while keeping the engine operating at peak efficiency.

Electronic Control Module.

The Electronic Control Module (ECM) works as the “brain” of the engine’s control system, responding quickly to operating variables to maximize engine efficiency. Fully integrated with sensors in the engine’s fuel, air, coolant, and exhaust systems, the ECM stores and relays information on conditions such as rpm, fuel consumption, and diagnostic information.

Fuel Delivery. The Cat C9 features electronic controls that govern the unit fuel injection system. Multiple injection fuel delivery involves a high degree of precision. Precisely shaping the combustion cycle lowers combustion chamber temperatures, generating fewer emissions and optimizing fuel combustion. This translates into more work output for your fuel cost.

Cooling System. The cooling fan is hydraulically driven and controlled by the ECM. The optimum fan speed is calculated based on the ambient temperature, coolant temperature and hydraulic oil temperature. This unique feature assists in the management of engine power and improves noise efficiency. Cat C9 delivered a completely new layout that separates the cooling system from the engine compartment.

Air Cleaner. The radial seal air filter features a double-layered filter core for more efficient filtration and is located in a compartment behind the cab. A warning is displayed on the monitor when dust accumulates above a preset level.

Noise Reduction Technologies.

The engine mounts are rubber-isolating mounts matched with the engine package. Further noise reduction has been achieved through design changes to the isolated top cover, oil pan, multiple injection strategy, insulated timing cover, sculpted crankcase and gear train refinements.

Hydraulics

Cat® hydraulics deliver power and precise control to keep material moving.

Component Layout. The component location and hydraulic system design provide the highest level of system efficiency. The main pumps, control valves and hydraulic tank are located close together to allow for shorter tubes and lines between components reducing friction loss and pressure drops in the lines. The layout further provides greater operator comfort by placing the radiator on the cab side of the upper structure. This allows incoming air to enter the engine compartment from the operator side and hot air and corresponding engine sound to exit on the opposite side away from the operator. This reduces engine compartment heat and sound transmitted to the operator.

Pilot System. The pilot pump is independent from the main pumps and controls the front linkage, swing and travel operations. The pilot control valve operation is proportional to control lever movement delivering outstanding controllability.

Hydraulic Cross Sensing System. The hydraulic cross sensing system utilizes each of two hydraulic pumps to 100 percent of engine power, under all operating conditions. This improves productivity with faster implement speeds and quicker, stronger pivot turns.

Boom and Stick Regeneration Circuit. Boom and stick regeneration circuit saves energy during boom-down and stick-in operation. This increases efficiency, reduces cycle times and pressure loss for higher productivity, lower operating costs and increased fuel efficiency.



Auxiliary Hydraulic Valve. The auxiliary valve is standard on the 330D L. Control Circuits are available as attachments, allowing for operation of high and medium pressure tools such as shears, grapples, hammers, pulverizers, multi-processors and vibratory plate compactors.

Hydraulic Cylinder Snubbers. Snubbers are located at the rod-end of the boom cylinders and both ends of the stick cylinders to cushion shocks while reducing sound levels and extending component life.

Operator Station

Designed for comfort, simple and easy operation, the 330D allows the operator to focus on production.



Operator Station. The workstation is spacious, quiet and comfortable, assuring high productivity during a long work day. The air conditioner and attachment switches are conveniently located on the right-hand wall, and the key switch and throttle dial are on the right-hand console. The monitor is easy to see and maximizes visibility.

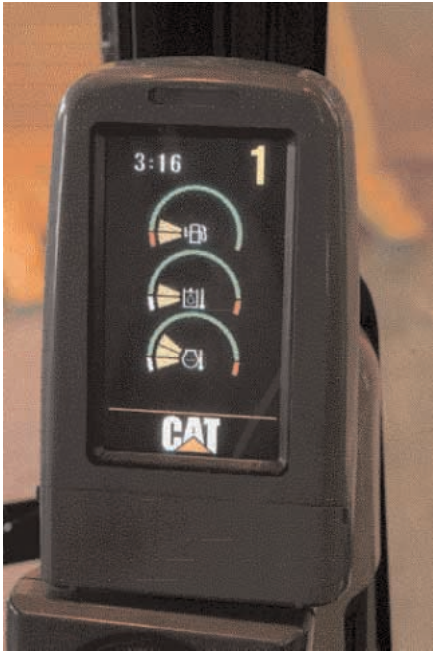

Monitor. The monitor is a full color 400x234 pixels Liquid Crystal Display (LCD) graphic display. The monitor angle is adjustable to minimize sun glare and is capable of displaying information in twenty-seven different languages.

Pre-Start Check. Prior to starting the machine, the system will check for low fluid levels for the engine oil, hydraulic oil and engine coolant and warn the operator through the monitor in the event display area.

Gauge Display. Fuel level, hydraulic oil temperature and coolant temperature are displayed in this area by analog gauges.

Event Display. An icon and the selected language display the machine information in this area.

Multi-information Display. This area is reserved for displaying various forms of operator information. The “CAT” logo is displayed when no information is available to be displayed.

Standard Cab Equipment. To enhance operator comfort and productivity, the cab includes a lighter, drink holder, coat hook, service meter, literature holder, magazine rack and storage compartment.

Seat. A new optional air suspension seat is available in the 330D. The standard and optional seats provide a variety of adjustments to suit the operator’s size and weight including fore/aft, height and weight. Wide adjustable armrests and a retractable seat belt are also included.

Joystick Control. Joystick controls have low lever effort and are designed to match the operator’s natural wrist and arm position. The operator can operate joystick controls with an arm on the armrest and the horizontal and vertical strokes have been designed to reduce operator fatigue.

Hydraulic Activation Control Lever. For added safety, this lever must be in the operate position to activate the machine control functions.

Automatic Climate Control. Fully automatic climate control adjusts temperature and flow, and determines which air outlet is best in each situation with a touch of a button.



Console. Redesigned consoles feature a simple, functional design to reduce operator fatigue, ease of switch operation and excellent visibility. Both consoles have attached armrests with height adjustments.

Cab Exterior. The exterior design uses thick steel tubing along the bottom perimeter of the cab, improving the resistance of fatigue and vibration. This design allows the FOGS to be bolted directly to the cab, at the factory or as an attachment later, enabling the machine to meet specifications and job site requirements.

Cab Mounts. The cab shell is attached to the frame with viscous rubber cab mounts, which dampen vibrations and sound levels while enhancing operator comfort.

Windows. All glass is affixed directly to the cab for excellent visibility eliminating window frames. The upper front windshield opens, closes and stores on the roof above the operator with a one-touch action release system.

Wipers. Pillar-mounted wipers increase the operator’s viewing area and offer continuous and intermittent modes.

Skylight. An enlarged skylight with sunshade provides excellent visibility and ventilation.

Structures

330D L structural components and undercarriage are the backbone of the machine's durability.

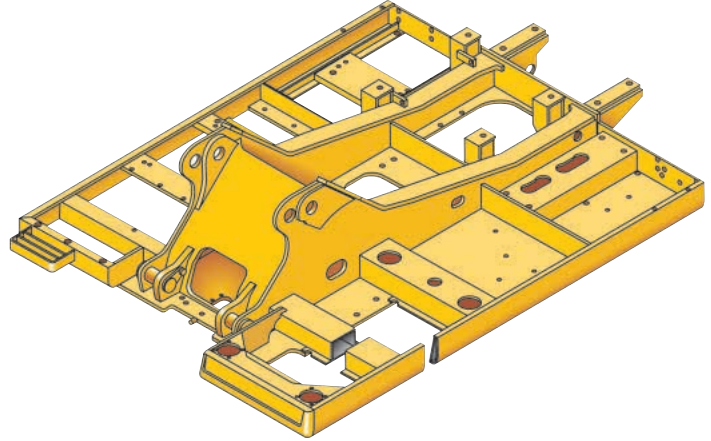
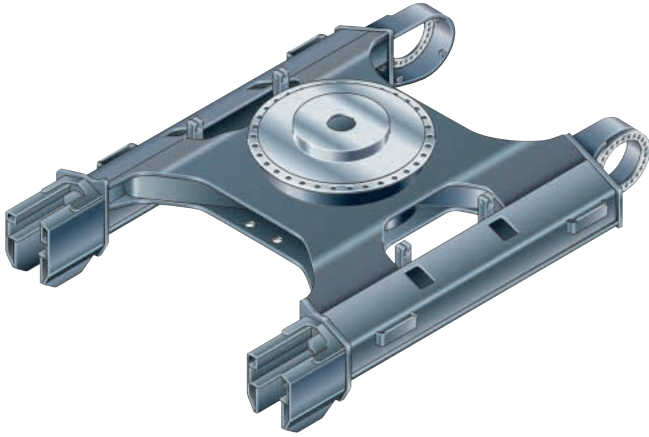

Robotic Welding. Up to 95% of the structural welds on a Caterpillar® Excavator are completed by robots. Robotic welds achieve over three times the penetration of manual welds.

Carbody Design and Track Roller Frames. X-shaped, box-section carbody provides excellent resistance to torsional bending. Robot-welded track roller frames are press-formed, pentagonal units to deliver exceptional strength and service life.

Main Frame. Rugged main frame is designed for maximum durability and efficient use of materials.

Undercarriage. Durable Cat® undercarriage absorbs stresses and provides excellent stability.

Swing Bearing. The swing bearing utilizes cross roller bearings versus the traditional ball bearing design. The cross roller bearing design allows for more surface contact to absorb the stresses that are a result of the high swing torque that Cat offers. It provides exceptional machine stability and reduces machine pitching during boom down operation.

Rollers and Idlers. Sealed and lubricated track rollers, carrier rollers, and idlers provide excellent service life, to keep the machine in the field longer.

Long Undercarriage. The long (L) undercarriage maximizes stability and lift capacity. This long, wide, and sturdy undercarriage offers a very stable work platform.

Booms, Sticks and Attachments

Designed for maximum flexibility, productivity and high efficiency on all jobs, the 330D L offers a wide range of configurations suitable for a variety of applications.

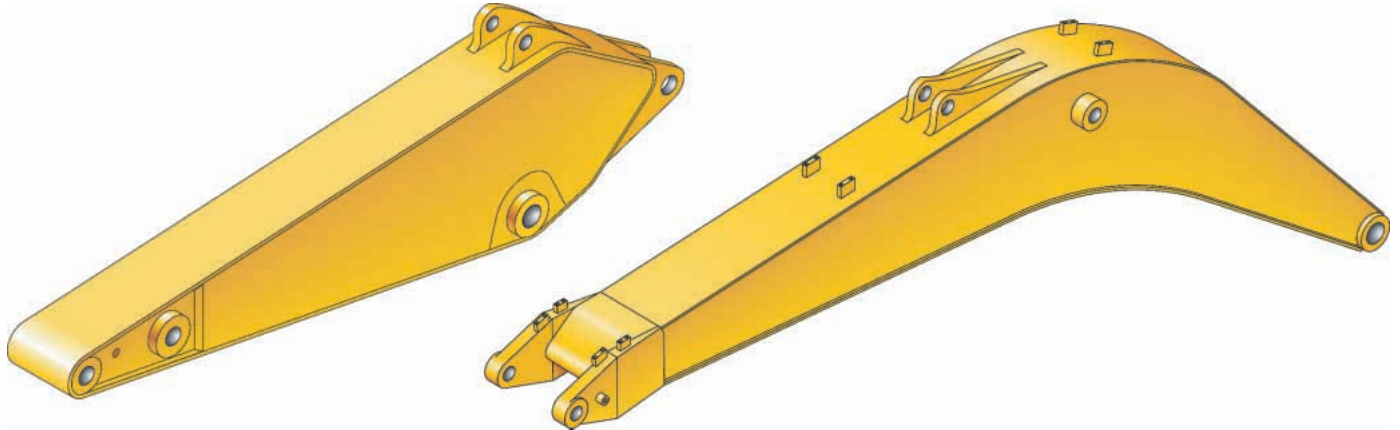

Reach Boom. The reach boom features an optimum design that maximizes digging envelopes with two stick choices:

R3.9DB, R3.2DB Sticks

- The DB-family bucket associated with these sticks have enough capacity for excellent reach and depth in trenching and general construction applications.

Mass Excavation Boom. The mass excavation boom maximizes productivity. The mass version offers significantly higher digging forces and allows use of larger buckets.

M2.55TB1 Stick

- The TB1 Stick use a TB-family bucket and were designed for high volume earth moving, powerful digging force and a large capacity bucket. Combined with a Mass boom, these sticks deliver outstanding productivity.

Linkage Pins. The bucket linkage pins have been enlarged to improve reliability and durability. All the pins in the front linkages have thick chrome plating, giving them high wear and corrosion resistance.

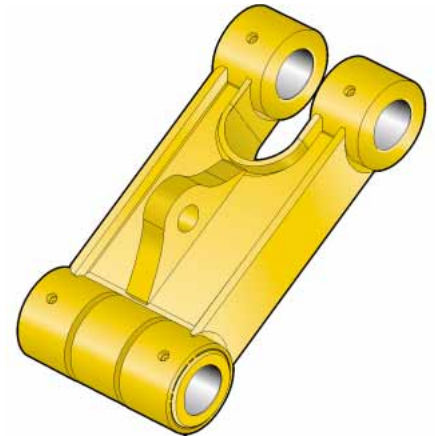

Bucket Linkage. The power link improves durability, increases machine-lifting capability in key lifting positions and is easier to use than compared to the previous lifting eye.

Work Tools – Attachments

The 330D L has an extensive selection of work tools to optimize machine performance.

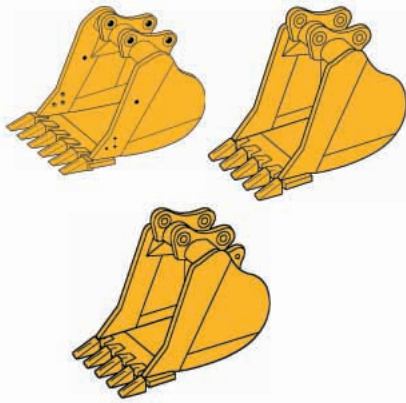

Heavy Duty Buckets. Heavy-duty buckets are used for a wide range of moderately abrasive applications such as mixed dirt, clay and rock. HD buckets have best loading and dumping characteristics and will empty easier in cohesive material. More robust construction than the GP buckets.

General Purpose Capacity (GP-C) Buckets. General purpose capacity buckets are best for digging in soft to hard ground with low to moderately abrasive materials.

Heavy-Duty Power (HDP) Buckets. Heavy-duty power buckets are for use in moderately abrasive applications where breakout force and cycle times are critical. Maximizes tip force and improves cycle times in most materials.

Heavy Duty Rock (HDR) Buckets. Heavy-duty rock buckets are for use in aggressive bucket loading in highly abrasive application such as shot rock and granite. HDR buckets include thicker bottom wear plates and longer side wear plates to extend the life of bucket in these severe applications.

Caterpillar Ground Engaging Tools

(GET). All buckets in the DB/TB Family utilize the Caterpillar K Series® GET. This GET system uses a vertical retainer that is easier to remove and install than the Cat J Series pin. The tip shapes are more aggressive and offer better penetration than the previous generation of tips. There are also a variety of side cutters and sidebar protectors to match operating conditions.

Dedicated Quick Coupler.

Quick Couplers increase the versatility of Cat excavators; allowing the ease of changing work tools to meet job requirements at hand in a matter of minutes or seconds. Dedicated quick coupler buckets have no loss of tip radius, and develop maximum breakout force.



Hammer

Cat Hydraulic Hammers are precisely matched to Cat machines for optimum performance in a wide variety of demolition and construction applications.



Thumb

Cat® thumbs multiply the capabilities of your excavator. This highly flexible tool works in conjunction with the bucket to transform an excavator into a highly versatile material-handling machine.



Multi-processor

Multi-processors do the work of many types of demolition tools by use of interchangeable jaw sets. Changing jaws allows a single unit to crush, pulverize and perform a variety of specialized cutting tasks, such as cutting steel rebar and tanks.

Versatility

A wide variety of optional factory installed attachments are available to enhance performance and improve job site management



Tool Control System. This system offers the most flexibility and versatility of the auxiliary options offered. This system is available in two configurations, as a stand-alone system or with a medium pressure circuit and third pump. This system is capable of running either one-way or two-way tools and one-pump or two pump tools. The addition of the medium pressure circuit allows use of tools that rotate such as grapples, shears or multi-processors. Up to 10 different tool settings can be pre-programmed and selected through the monitor.

Auxiliary Hydraulic Options. There are four different options that can be factory installed to meet the various demands for hydra-mechanical tools.

- Single-Function
- Double-Function
- Tool Control System without Medium Pressure
- Tool Control System with Medium Pressure

Single-Function Auxiliary Hydraulics.

This circuit utilizes one-way flow with two pumps and can run tools such as hammers and vibratory plate compactors.

Double-Function Auxiliary Hydraulics.

This circuit utilizes two-way flow and one pump and is capable of running tools such as a thumb, tilt-bucket or non-rotating grapples or shears.

Hydraulic Kits. Field installed hydraulic kits are available that are identical to the factory installed version in both component and functionality.

The flexibility of the base hydraulic design allows for upgradeability to any auxiliary hydraulic option.

Machine Security. An optional Machine Security System is available from the factory on the 330D L. This system controls when the machine can be operated and utilizes specific keys to prevent unauthorized machine use, a significant theft deterrent.

Product Link. The machine is pre-wired to accept Product Link systems to be installed in the field. Product Link is also available as a factory installed attachment. Product Link can assist with Fleet Management that will keep track of hours, location, security and product health.

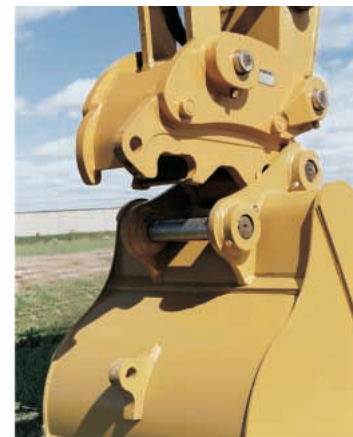

Pin Grabber Plus Hydraulic Pin Grabber

Increases versatility of the excavator by allowing the machine to pick up a wide variety of work tools without leaving the cab.



360° Scrap Shear

Caterpillar Scrap Shears feature 360° rotation and high force-to-weight ratio. Used for demolishing steel structures and preparing bulk scrap (such as cars, farm machinery and railroad cars) for further processing.

Service and Maintenance

Simplified service and maintenance features save you time and money.

Ground Level Service. The design and layout of the 330D L was made with the service technician in mind. Many service locations are easily accessible at ground level allowing critical maintenance to get done quickly and efficiently.



Air Filter Compartment. The air filter features a double-element construction for superior cleaning efficiency. When the air cleaner plugs, a warning is displayed on the monitor screen inside the cab.

Pump Compartment. A service door on the right side of the upper structure allows ground-level access to the pump and pilot filter.



Radiator Compartment. The left rear service door allows easy access to the engine radiator, oil cooler and air-to-air-after-cooler. A reserve tank and drain cock are attached to the radiator for simplified maintenance.



Greasing Points. A concentrated remote greasing block on the boom delivers grease to hard-to-reach locations on the front.

Capsule Filter. The hydraulic return filter, a capsule filter, is situated outside the hydraulic tank. This filter prevents contaminants from entering the system when hydraulic oil is changed and keeps the operation clean.

Fan Guard. Engine radiator fan is completely enclosed by fine wire mesh, reducing the risk of an accident.

Anti-Skid Plate. Anti-skid plate covers top of storage box and upper structure to prevent slipping during maintenance.



Diagnostics and Monitoring.

The 330D L is equipped with S•O•SSM sampling ports and hydraulic test ports for the hydraulic system, engine oil, and for coolant. A test connection for the Cat Electronic Technician (Cat ET) service tool is located in the cab.

Complete Customer Support

Cat® dealer services help you operate longer with lower costs.



Product Support. You will find nearly all parts at our dealer parts counter. Cat dealers utilize a worldwide computer network to find in-stock parts to minimize machine down time. Save money with remanufactured components.

Machine Selection. Make detailed comparisons of the machines you are considering before you buy. What are the job requirements, machine attachments and operating hours? What production is needed? Your Cat dealer can provide recommendations.

Customer Support Agreements.

Cat dealers offer a variety of product support agreements, and work with customers to develop a plan the best meets specific needs. These plans can cover the entire machine, including attachments, to help protect the customer's investment.

Operation. Improving operating techniques can boost your profits. Your Cat dealer has videotapes, literature and other ideas to help you increase productivity, and Caterpillar offers certified operator training classes to help maximize the return on your investment.

Maintenance Services. Repair option programs guarantee the cost of repairs up front. Diagnostic programs such as Scheduled Oil Sampling, Coolant Sampling and Technical Analysis help you avoid unscheduled repairs.

Replacement. Repair, rebuild, or replace? Your Cat dealer can help you evaluate the cost involved so you can make the right choice.

Engine

Engine Model	Cat C9 with ACERT™ Technology	
Net Flywheel Power	200 kW	268 hp
Net Power – ISO 9249	200 kW	268 hp
Net Power – SAE J1349	188 kW	252 hp
Net Power – EEC 80/1269	200 kW	268 hp
Bore	112 mm	4.4 in
Stroke	149 mm	5.87 in
Displacement	8.8 L	537 in ³

- The 330D L meets U.S. EPA Tier 3 and EU Stage IIIA exhaust emission requirements.
- Net power advertised is the power available at the flywheel when the engine is equipped with fan, air cleaner, muffler and alternator.
- No engine power derating required below 2300 m (7,500 ft).

Weights

Operating Weight	36 151 kg	79,700 lb
------------------	-----------	-----------

- Reach boom, R3.9DB (12 ft 6 in) Stick, 1.19 m³ (1.56 yd³) GP Bucket, 800 mm (32 in) Shoe

Service Refill Capacities

Fuel Tank Capacity	620 L	163.8 gal
Cooling System	40 L	10.6 gal
Engine Oil	40 L	10.6 gal
Swing Drive	19 L	5 gal
Final Drive (each)	8 L	2.1 gal
Hydraulic System (including tank)	410 L	108.3 gal
Hydraulic Tank	175 L	46.2 gal

Swing Mechanism

Swing Speed	10 RPM	
Swing Torque	108.7 kN-m	80,142 lb ft

Drive

Maximum Drawbar Pull	300 kN	67,443 lb
Maximum Travel Speed	5 km/h	3.1 mph

Hydraulic System

Main Implement System – Maximum Flow (2x)	280 L/min	74 gal/min
Max. pressure – Equipment	35 000 kPa	5,076 psi
Max. pressure – Equipment – Heavy	36 000 kPa	5,221 psi
Max. pressure – Travel	35 000 kPa	5,076 psi
Max. pressure – Swing	28 000 kPa	4,061 psi
Pilot System – Maximum flow	43 L/min	11.4 gal/min
Pilot System – Maximum pressure	4000 kPa	565.7 psi
Boom Cylinder – Bore	150 mm	5.9 in
Boom Cylinder – Stroke	1440 mm	56.7 in
Stick Cylinder – Bore	170 mm	6.7 in
Stick Cylinder – Stroke	1738 mm	68.4 in
DB Family Bucket Cylinder – Bore	150 mm	5.9 in
DB Family Bucket Cylinder – Stroke	1151 mm	45.3 in
TB1 Family Bucket Cylinder – Bore	160 mm	6.3 in
TB1 Family Bucket Cylinder – Stroke	1356 mm	53.4 in

Sound Performance

Performance	ANSI/SAE J1166 OCT 98
-------------	-----------------------

- When properly installed and maintained, the cab offered by Caterpillar, when tested with doors and windows closed according to ANSI/SAE J1166 OCT 98, meets OSHA and MSHA requirements for operator sound exposure limits in effect at time of manufacture.
- Hearing protection may be needed when operating with an open operator station and cab (when not properly maintained or doors/windows open) for extended periods or in noisy environment.

Standards

Brakes	SAE J1026 APR90
Cab/FOGS	SAE J1356 FEB88

Dimensions

All dimensions are approximate.

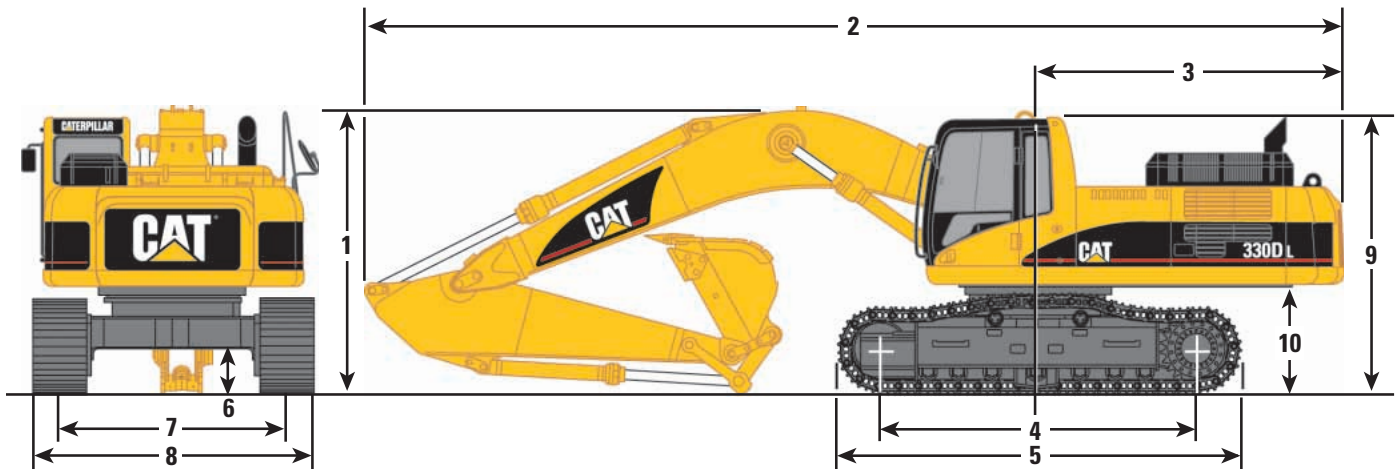

Boom Options	Reach Boom 6.5 m (21'4")		Mass Boom 6.18 m (20'3")
Stick Options	R3.9DB (12'10")	R3.2DB (10'6")	M2.55TB1 (8'4")
1 Shipping height*	3630 mm (11'11")	3350 mm (11'0")	3580 mm (11'9")
2 Shipping length	11 200 mm (36'9")	11 150 mm (36'7")	10 910 mm (35'10")
3 Tail swing radius	3500 mm (11'6")	3500 mm (11'6")	3500 mm (11'6")
4 Length to center of rollers	4040 mm (13'3")	4040 mm (13'3")	4040 mm (13'3")
5 Track length	5020 mm (16'6")	5020 mm (16'6")	5020 mm (16'6")
6 Ground clearance**	450 mm (1'6")	450 mm (1'6")	450 mm (1'6")
7 Track gauge	2590 mm (8'6")	2590 mm (8'6")	2590 mm (8'6")
8 Transport width			
800 mm (32") shoes (standard)	3390 mm (11'1")	3390 mm (11'1")	3390 mm (11'1")
700 mm (28") shoes (optional)	3290 mm (10'10")	3290 mm (10'10")	3290 mm (10'10")
850 mm (34") shoes (optional)	3440 mm (11'3")	3440 mm (11'3")	3440 mm (11'3")
9 Cab height	3140 mm (10'4")	3140 mm (10'4")	3140 mm (10'4")
10 Counterweight clearance*	1220 mm (4'0")	1220 mm (4'0")	1220 mm (4'0")

* Includes 30 mm (1³/₁₆ in) lug height. R3.9 increase to 3700 mm (12'2") with medium pressure and/or drain auxiliary lines.

** Without 30 mm (1³/₁₆ in) shoe lug height.

Reach Excavator Working Ranges

Reach (R) boom configuration

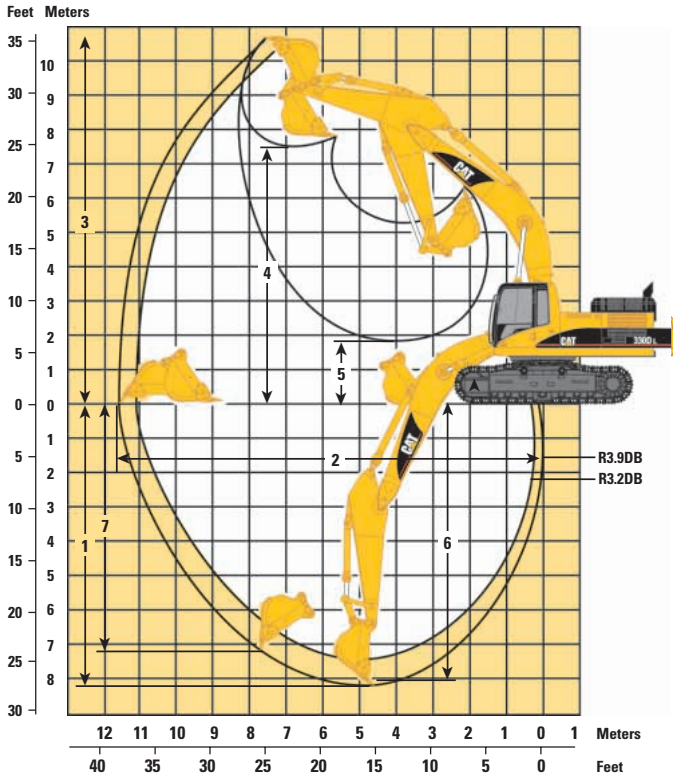

Mass Excavator Working Ranges

Mass (M) boom configuration

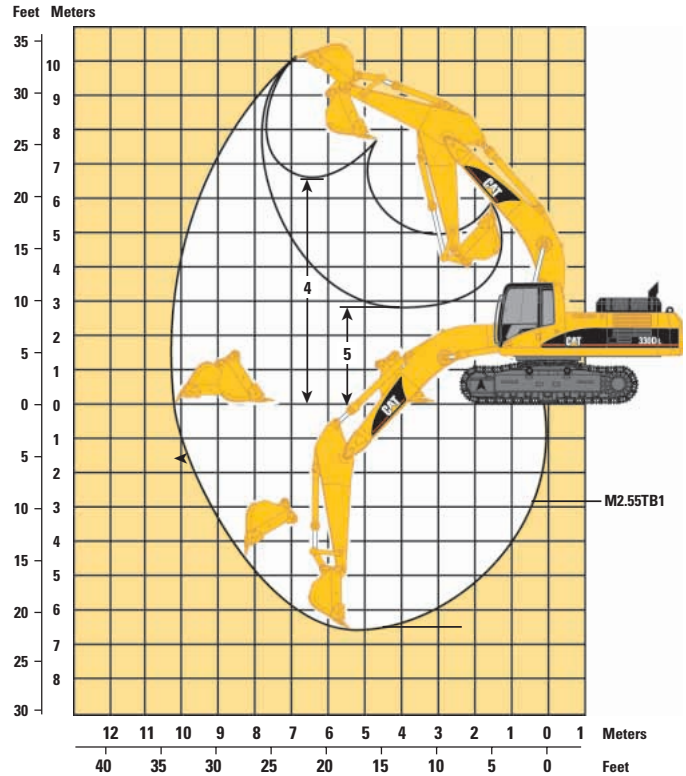

Boom Options

Stick Options

R3.9DB
(12'10")

R3.2DB
(10'6")

R3.9DB
(12'10")

R3.2DB
(10'6")

Mass Boom

M2.55TB1
(8'4")

Bucket Options

GP 1.19 m³
(1.56 yd³)

GP 1.19 m³
(1.56 yd³)

GP 1.19 m³
(1.56 yd³)
with Pin
Grabber
Coupler

GP 1.19 m³
(1.56 yd³)
with Pin
Grabber
Coupler

GP 1.19 m³
(1.56 yd³)

	R3.9DB (12'10")	R3.2DB (10'6")	R3.9DB (12'10")	R3.2DB (10'6")	M2.55TB1 (8'4")
1 Maximum digging depth	8185 mm (26'10")	7485 mm (24'7")	8461 mm (27'9")	7760 mm (25'6")	6633 mm (21'9")
2 Maximum reach at ground level	11 714 mm (38'5")	11 007 mm (36'1")	12 005 mm (39'5")	11 294 mm (37'1")	10 242 mm (33'7")
3 Maximum cutting height	10 749 mm (35'3")	10 272 mm (33'8")	10 909 mm (35'9")	10 413 mm (34'2")	10 023 mm (32'11")
4 Maximum loading height	7542 mm (24'9")	7108 mm (23'4")	7266 mm (23'10")	6833 mm (22'5")	6629 mm (21'9")
5 Minimum loading height	1911 mm (6'3")	2611 mm (8'7")	1635 mm (5'4")	2336 mm (7'8")	2937 mm (9'8")
6 Maximum depth cut for 2440 mm (8') level bottom	8052 mm (26'5")	7326 mm (24'0")	8338 mm (27'4")	7612 mm (25'0")	6459 mm (21'2")
7 Maximum vertical wall digging depth	7152 mm (23'6")	6131 mm (20'1")	5747 mm (18'10")	4826 mm (15'10")	4421 mm (14'6")

Bucket and Stick Forces

Stick Options	R3.9DB		R3.9DB with Pin Grabber Coupler		R3.2DB		R3.2DB with Pin Grabber Coupler		M2.55TB1	
	kN	lb	kN	lb	kN	lb	kN	lb	kN	lb
DB-Family Buckets										
Heavy Duty-Power										
Bucket Digging Force (ISO)	238.3	53,572	198.2	44,557	237.7	53,437	197.4	44,377		
Stick Digging Force (ISO)	151.9	34,148	144.9	32,575	170.0	38,218	160.1	35,992		
Bucket Digging Force (SAE)	208.6	46,895	180.8	40,645	208.0	46,760	180.0	40,466		
Stick Digging Force (SAE)	147.8	33,227	141.9	31,900	164.6	37,004	156.3	35,138		
Heavy Duty										
Bucket Digging Force (ISO)	214.3	48,177	187.4	42,129	213.6	48,019	186.7	41,972		
Stick Digging Force (ISO)	149.3	33,564	142.2	31,968	166.6	37,453	156.8	35,250		
Bucket Digging Force (SAE)	188.5	42,376	171.0	38,442	187.9	42,242	170.4	38,307		
Stick Digging Force (SAE)	145.0	32,597	139.1	31,271	161.0	36,194	152.8	34,351		
General Purpose										
Bucket Digging Force (ISO)	213.8	48,064	188.6	42,399	213.3	47,952	187.8	42,219		
Stick Digging Force (ISO)	149.3	33,564	142.6	32,058	166.8	37,498	157.4	35,385		
Bucket Digging Force (SAE)	191.1	42,961	174.4	39,207	190.6	42,849	173.9	39,094		
Stick Digging Force (SAE)	145.9	32,800	140.2	31,518	162.3	36,486	154.2	34,666		
TB-Family Buckets										
Heavy Duty										
Bucket Digging Force (ISO)									271.0	60,923
Stick Digging Force (ISO)									195.2	43,883
Bucket Digging Force (SAE)									239.6	53,864
Stick Digging Force (SAE)									188.0	42,264

Major Component Weights*

	kg	lb
Base machine with counterweight (without front linkage)		
With 800 mm (32") shoe	29 117	64,192
Two boom cylinders (each)	674	1,486
Counterweight		
Standard counterweight	6020	13,272
Boom (includes lines, pins and stick cylinder)		
Reach boom 6.5 m (20'3")	3255	7,176
Mass boom 6.18 m (20'4")	3283	7,238
Stick (includes lines, pins, bucket cylinder and linkage)		
R3.9 (12'10")	2012	4,436
R3.2 (10'6")	1867	4,116
M2.55 (8'5")	2079	4,583

* All weights are approximate.

Bucket Specifications and Compatibility

Bucket Type	Adaptor	Capacity*		Width		Tip Radius		Teeth Qty	Total Weight		Reach Boom Stick		Mass Boom Stick M2.55TB
		m ³	yd ³	mm	in	mm	in		kg	lb	R3.9DB	R3.2DB	
DB Family Buckets													
General Purpose	K100	0.94	1.23	762	30	1753.4	69.0	3	993	2,189	●	●	
	K100	1.19	1.56	914	36	1753.4	69.0	4	1088	2,398	●	●	
	K100	1.46	1.91	1067	42	1753.4	69.0	5	1200	2,646	●	●	
	K100	1.73	2.26	1219	48	1753.4	69.0	5	1288	2,839	●	●	
	K100	2.00	2.62	1372	54	1753.4	69.0	6	1401	3,089	●	●	
	K100	2.27	2.97	1524	60	1753.4	69.0	7	1515	3,339	○	○	
	K100	2.55	3.34	1676	66	1753.4	69.0	7	1602	3,532	∴	○	
Heavy Duty	K110	0.74	0.97	762	30	1779.1	70.0	3	1070	2,358	●	●	
	K110	0.95	1.24	914	36	1779.1	70.0	4	1216	2,682	●	●	
	K110	1.18	1.54	1067	42	1779.1	70.0	4	1310	2,889	●	●	
	K110	1.41	1.84	1219	48	1779.1	70.0	5	1441	3,178	●	●	
	K110	1.64	2.15	1372	54	1779.1	70.0	5	1539	3,393	●	●	
	K110	1.87	2.45	1524	60	1779.1	70.0	6	1672	3,686	●	●	
	K110	2.10	2.75	1676	66	1779.1	70.0	7	1805	3,979	○	○	
	K110	2.34	3.06	1829	72	1779.1	70.0	7	1904	4,197	∴	○	
Heavy Duty Rock	K110	0.74	0.97	762	30	1779.1	70.0	3	1131	2,493	●	●	
	K110	0.95	1.24	914	36	1779.1	70.0	4	1293	2,849	●	●	
	K110	1.18	1.54	1067	42	1779.1	70.0	4	1400	3,086	●	●	
	K110	1.41	1.84	1219	48	1779.1	70.0	5	1547	3,411	●	●	
	K110	1.64	2.15	1372	54	1779.1	70.0	5	1660	3,659	●	●	
Heavy Duty Power	K110	0.95	1.24	914	36	1681.8	66.2	4	1192	2,628	●	●	
	K110	1.40	1.83	1219	48	1681.8	66.2	5	1421	3,132	●	●	
	K110	1.63	2.13	1372	54	1681.8	66.2	5	1518	3,346	●	●	
	K110	1.86	2.43	1524	60	1681.8	66.2	6	1650	3,637	●	●	
Ditch Cleaning	N/A	1.63	2.13	1524	60	1410.0	55.5	–	1088	2,399	●	●	
	N/A	1.91	2.50	1830	72	1410.0	55.5	–	1217	2,683	●	●	
TB Family Buckets													
Heavy Duty	K110	2.40	3.14	1676	66	1869	73.6	7	2211	2358			○
	K110	2.70	3.53	1829	72	1869	73.6	7	2355	4197			○

Assumptions for maximum material density rating:

1. Front linkage fully extended at ground line
2. Bucket curled
3. 100% bucket fill factor

* Capacities based on SAE J296. Some calculations of capacity fall on borderlines.

Rounding may allow two buckets to have the same English rating but different metric ratings.

- 2100 kg/m³ (3,500 lb/yd³) max material density
- 1800 kg/m³ (3,000 lb/yd³) max material density
- 1500 kg/m³ (2,500 lb/yd³) max material density
- 1200 kg/m³ (2,000 lb/yd³) max material density
- ∴ 900 kg/m³ (1,500 lb/yd³) max material density

330D L Work Tool Matching Guide

Boom Options	Reach Boom 6.5 m (21'4")		Mass Boom 6.18 m (20'4")
Stick Options	R3.9DB (12'10")	R3.2DB (10'6")	M2.55TB (8'4")
Hydraulic Hammer	H130s/ H140Ds/ H160Ds	H130s/ H140Ds/ H160Ds	H130s/ H140Ds/ H160Ds
Multi-Processor	MP20 MP40 (Boom Mount)	MP20/MP30 MP40 (Boom Mount)	MP30 N/A
360° Scrap Shear	S320/S325* S365B (Boom Mount)	S320/S325* S365B (Boom Mount)	S325 N/A
Mechanical Shear	S128	S128	S128
Mechanical Pulverizer	P130	P130	P130
Trash Grapple**	Available as field installed attachment only		
Contractors' Grapple**	Available as field installed attachment only		
Rotating Sorting/Demolition Grapple	G320/G330	G320/G330	G320/G330
Vibratory Plate Compactor	CVP110	CVP110	CVP110
Hydraulic Thumb**	Available as field installed attachment only		
Dedicated Quick Coupler**	Available as field installed attachment only		
Pin-Grabber Quick Coupler	Available as factory or field installed attachment		N/A

* S325 only without PG Coupler.

** Contact Cat Work Tools for availability and proper matching.

Reach Boom Lift Capacities



Load Point Height



Load Radius Over Front



Load Radius Over Side



Load at Maximum Reach – Bucket Curled





Load at Maximum Reach – Bucket Extended

BOOM – 6.5 m (21'4")
STICK – 3.9 m (12'10")

BUCKET – DB 36" GP
with General Duty Tips (x4)
1078.6 kg (2,378 lb)

SHOES – 800 mm (32") triple grouser
UNDERCARRIAGE – Long
HEAVY LIFT – On

	1.5 m (5.0 ft)		3.0 m (10.0 ft)		4.5 m (15.0 ft)		6.0 m (20.0 ft)		7.5 m (25.0 ft)		9.0 m (30.0 ft)						
	kg	lb	kg	lb	kg	lb	kg	lb	kg	lb	kg	lb	kg	lb	m	ft	
9.0 m 30.0 ft	kg												*4390	*4390	7.84	9.36	
	lb												*9,800	*9,800	25.28	30.30	
7.5 m 25.0 ft	kg												*4070	*4070	8.97	10.39	
	lb												*9,000	*9,000	29.17	33.87	
6.0 m 20.0 ft	kg												*6170	4730	9.73	11.07	
	lb												*13,700	*13,700	31.80	36.20	
4.5 m 15.0 ft	kg												*7000	6490	10.22	11.47	
	lb												*15,250	13,950	33.48	37.58	
3.0 m 10.0 ft	kg												*6510	4620	10.47	11.62	
	lb												*13,600	10,100	34.35	38.12	
1.5 m 5.0 ft	kg												*3990	3510	10.51	11.54	
	lb												*8,800	7,800	34.47	37.88	
Ground Line	kg												*4420	3160	10.32	11.23	
	lb												*9,750	6,950	33.85	36.85	
-1.5 m -5.0 ft	kg	*7090	*7090	*11 250	*11 250	*18 200	11 610	13 080	7470	9140	5310	6860	3970	*5600	3400	9.90	10.66
	lb	*15,850	*15,850	*25,450	*25,450	*39,400	24,950	28,100	16,050	19,650	11,400	14,750	8,550	*12,350	7,500	32.45	34.94
-3.0 m -10.0 ft	kg	*11 300	*11 300	*16 070	*16 070	*17 720	11 570	12 980	7380	9070	5250	6860	3970	6620	3830	9.22	9.78
	lb	*25,300	*25,300	*36,350	*36,350	*38,350	24,850	27,850	15,850	19,500	11,300	14,800	8,550	14,650	8,500	30.16	31.99
-4.5 m -15.0 ft	kg	*16 260	*16 260	*21 170	*21 170	*16 140	11 750	*12 000	7470	*9060	5340			*7720	4700	8.21	
	lb	*36,550	*36,550	*47,200	*47,200	*34,800	25,300	*25,800	16,100	*19,300	11,500			*17,050	10,500	26.73	
-6.0 m -20.0 ft	kg															6.72	
	lb																

* Limited by hydraulic capacity rather than tipping load. The above loads are in compliance with SAE hydraulic excavator lift capacity rating standard J1097. They do not exceed 87% of hydraulic lifting capacity or 75% of tipping capacity. Weight of all lifting accessories must be deducted from the above lifting capacities.

Always refer to the appropriate Operation and Maintenance Manual for specific product information.

Reach Boom Lift Capacities



Load Point Height



Load Radius Over Front



Load Radius Over Side



Load at Maximum Reach - Bucket Curled





Load at Maximum Reach - Bucket Extended

BOOM – 6.5 m (21'4")
STICK – 3.2 m (10'6")

BUCKET – DB 36" GP
with General Duty Tips (x4)
1078.6 kg (2,378 lb)

SHOES – 800 mm (32") triple grouser
UNDERCARRIAGE – Long
HEAVY LIFT – On

	1.5 m (5.0 ft)		3.0 m (10.0 ft)		4.5 m (15.0 ft)		6.0 m (20.0 ft)		7.5 m (25.0 ft)		9.0 m (30.0 ft)											
	kg	lb	kg	lb	kg	lb	kg	lb	kg	lb	kg	lb	kg	lb	m	ft	kg	lb	m	ft		
9.0 m 30.0 ft	kg																					
	lb																					
7.5 m 25.0 ft	kg								*6850	6680							*5360	*5360	8.11	*3920	*3920	9.58
	lb								*15,150	14,250							*11,850	*11,850	26.34	*8,650	*8,650	31.18
6.0 m 20.0 ft	kg								*7090	6610							*5230	4650	8.95	*3870	3730	10.32
	lb								*15,500	14,150							*11,550	10,350	29.23	*8,550	8,300	33.74
4.5 m 15.0 ft	kg							*8880	*8880	*7770	6380	*7160	4550				*5300	4070	9.48	*3940	3340	10.75
	lb							*19,200	*19,200	*16,900	13,700	*15,700	9,700				*11,700	9,050	31.06	*8,650	7,400	35.22
3.0 m 10.0 ft	kg				*14 300	13 590	*10 520	8700	*8650	6070	7320	4410					*5550	3760	9.76	*4110	3150	10.92
	lb				*30,700	29,350	*22,750	18,750	*18,750	13,050	15,700	9,450					*12,200	8,300	31.99	*9,050	6,950	35.81
1.5 m 5.0 ft	kg				*17 000	12 440	*12 020	8120	*9500	5760	7150	4250					*5990	3640	9.79	*4400	3110	10.83
	lb				*36,650	26,800	*26,000	17,500	*20,600	12,400	15,350	9,100					*13,200	8,050	32.12	*9,700	6,850	35.55
Ground Line	kg			*7130	*7130	*18 220	11 850	*13 010	7720	9360	5520	7010	4120				6340	3710	9.59	*4860	3240	10.49
	lb			*16,350	*16,350	*39,450	25,500	*28,150	16,600	20,100	11,850	15,100	8,850				14,000	8,150	31.46	*10,700	7,150	34.43
-1.5 m -5.0 ft	kg	*8530	*8530	*12 500	*12 500	*18 200	11 680	13 130	7530	9210	5390	6960	4070				6810	3980	9.14	*5570	3590	9.87
	lb	*19,050	*19,050	*28,300	*28,300	*39,450	25,100	28,200	16,200	19,800	11,600						15,050	8,800	29.94	*12,300	7,950	32.35
-3.0 m -10.0 ft	kg	*13 870	*13 870	*18 930	*18 930	*17 180	11 770	*12 820	7520	9220	5390						7790	4580	8.39	*5550	4310	8.90
	lb	*31,050	*31,050	*42,400	*42,400	*37,200	25,300	*27,700	16,200	19,850	11,600						17,300	10,150	27.43	*12,100	9,600	29.09
-4.5 m -15.0 ft	kg			*20 610	*20 610	*14 970	12 070	*11 220	7700								*8510	5850	7.26			
	lb			*44,450	*44,450	*32,250	25,950	*24,000	16,600								*18,750	13,100	23.61			
-6.0 m -20.0 ft	kg					*10 610	*10 610															
	lb					*22,100	*22,100															

* Limited by hydraulic capacity rather than tipping load. The above loads are in compliance with SAE hydraulic excavator lift capacity rating standard J1097. They do not exceed 87% of hydraulic lifting capacity or 75% of tipping capacity. Weight of all lifting accessories must be deducted from the above lifting capacities.

Always refer to the appropriate Operation and Maintenance Manual for specific product information.

Reach Boom Lift Capacities



Load Point Height



Load Radius Over Front



Load Radius Over Side



















Load at Maximum Reach – Coupler Curled

BOOM – 6.5 m (21'4")
STICK – 3.9 m (12'10")

BUCKET – No Bucket,
Bare Coupler Only

SHOES – 800 mm (32") triple grouser
UNDERCARRIAGE – Long
HEAVY LIFT – On

	1.5 m (5.0 ft)		3.0 m (10.0 ft)		4.5 m (15.0 ft)		6.0 m (20.0 ft)		7.5 m (25.0 ft)		9.0 m (30.0 ft)				m ft		
																	
9.0 m 30.0 ft	kg lb														*4770 *10,600	*4770 *10,600	7.88 25.42
7.5 m 25.0 ft	kg lb											*4450	*4450		*4430 *9,800	*4430 *9,800	9.00 29.29
6.0 m 20.0 ft	kg lb									*14,500	*14,500	*6550	5080		*4290 *9,500	*4290 *9,500	9.77 31.92
4.5 m 15.0 ft	kg lb									*7340	6800	*6880	4950		*4300 *9,450	3840 8,500	10.26 33.59
3.0 m 10.0 ft	kg lb					*12 830 *27,600	*12 830 *27,600	*9840 *21,300	9180 19,800	*8300 *18,000	6450 13,900	*7400 *16,150	4760 10,250		*4430 *9,750	3580 7,900	10.51 34.46
1.5 m 5.0 ft	kg lb					*16 020 *34,550	13 090 28,200	*11 550 *25,000	8540 18,400	*9280 *20,150	6100 13,150	7470 16,050	4560 9,800		*4680 *10,300	3480 7,650	10.54 34.58
Ground Line	kg lb			*8110 *18,500	*8110 *18,500	*17 970 *38,850	12 290 26,450	*12 840 *27,800	8060 17,350	9650 20,750	5810 12,500	7290 15,700	4400 9,450		*5110 *11,250	3510 7,750	10.35 33.96
-1.5 m -5.0 ft	kg lb	*7370 *16,450	*7370 *16,450	*11 620 *26,250	*11 620 *26,250	*18 590 *40,300	11 930 25,650	13 380 28,750	7770 16,750	9440 20,300	5620 12,100	7170 15,450	4290 9,250		*5780 *12,800	3710 8,200	9.93 32.57
-3.0 m -10.0 ft	kg lb	*11 590 *25,950	*11 590 *25,950	*16 410 *37,100	*16 410 *37,100	*18 130 *39,250	11 880 25,550	13 260 28,500	7680 16,550	9370 20,150	5550 11,950	7170 15,450	4290 9,250		6890 15,250	4130 9,150	9.26 30.28
-4.5 m -15.0 ft	kg lb	*16 550 *37,200	*16 550 *37,200	*23 010 *50,950	*23 010 *50,950	*16 560 *35,750	12 050 25,900	*12 400 *26,700	7760 16,750	*9460 *20,200	5630 12,150				*8050 *17,750	4960 11,050	8.25 26.87
-6.0 m -20.0 ft	kg lb			*18 550 *39,500	*18 550 *39,500	*13 390 *28,450	12 460 26,850	*9820 *20,600	8060 17,450						*8040 *17,700	6840 15,500	6.77 21.81

* Limited by hydraulic capacity rather than tipping load. The above loads are in compliance with SAE hydraulic excavator lift capacity rating standard J1097. They do not exceed 87% of hydraulic lifting capacity or 75% of tipping capacity. Weight of all lifting accessories must be deducted from the above lifting capacities.

Always refer to the appropriate Operation and Maintenance Manual for specific product information.

Reach Boom Lift Capacities



Load Point Height



Load Radius Over Front



Load Radius Over Side



Load at Maximum Reach – Coupler Curled

BOOM – 6.5 m (21'4")
STICK – 3.2 m (10'6")

BUCKET – No Bucket,
Bare Coupler Only

SHOES – 800 mm (32") triple grouser
UNDERCARRIAGE – Long
HEAVY LIFT – On

 9.0 m 30.0 ft kg lb	1.5 m (5.0 ft)		3.0 m (10.0 ft)		4.5 m (15.0 ft)		6.0 m (20.0 ft)		7.5 m (25.0 ft)		9.0 m (30.0 ft)		 m ft		
	 kg lb	 kg lb	 kg lb	 kg lb	 kg lb	 kg lb	 kg lb	 kg lb	 kg lb	 kg lb	 kg lb	 kg lb	 kg lb	 kg lb	 kg lb
9.0 m 30.0 ft kg lb															*6150 *6150 6.89
7.5 m 25.0 ft kg lb									*7220 *16,000	7030 15,050					*5680 *12,600 *5680 *12,600 8.15 26.47
6.0 m 20.0 ft kg lb									*7450 *16,300	6930 14,900					*5530 *12,200 4970 11,050 8.99 29.35
4.5 m 15.0 ft kg lb								*9190 *19,900	*9190 *19,900	*8110 *17,650	6680 14,400	*7530 *16,500	4,880 10,450		*5570 *12,250 4390 9,750 9.52 31.17
3.0 m 10.0 ft kg lb					*14 580 *31,350	13 870 29,950	*10 840 *23,450	8980 19,350	*8990 *19,500	6370 13,700	7640 16,450	4730 10,150			*5780 *12,750 4080 9,000 9.79 32.10
1.5 m 5.0 ft kg lb					*17 340 *37,400	12 760 27,500	*12 360 *26,750	8420 18,150	*9850 21,350	6060 13,050	7460 16,050	4570 9,800			*6190 *13,650 3950 8,700 9.82 32.23
Ground Line kg lb			*7480 *17,100	*7480 *17,100	*18 610 *40,300	12 190 26,250	*13 370 *28,950	8030 17,300	9660 20,800	5820 12,550	7330 15,750	4440 9,550			6620 14,600 4010 8,850 9.62 31.57
-1.5 m -5.0 ft kg lb	*8720 *19,450	*8720 *19,450	*12 800 *28,950	*12 800 *28,950	*18 620 *40,350	12 020 25,850	13 430 28,850	7830 16,900	9510 20,450	5690 12,250	7270 15,650	4390 9,450			7080 15,600 4270 9,450 9.17 30.06
-3.0 m -10.0 ft kg lb	*14 080 *31,550	*14 080 *31,550	*19 210 *43,500	*19 210 *43,500	*17 610 *38,150	12 080 26,000	*13 200 *28,550	7820 16,850	9510 20,500	5690 12,250					8040 17,800 4860 10,750 8.43 27.56
-4.5 m -15.0 ft kg lb			*21 130 *45,550	*21 130 *45,550	*15 410 *33,200	12 350 26,600	*11 620 *24,900	7990 17,250							*8820 *19,450 6090 13,600 7.31 23.76
-6.0 m -20.0 ft kg lb					*11 070 *23,100	*11 070 *23,100									*8470 *8470 5.58

* Limited by hydraulic capacity rather than tipping load. The above loads are in compliance with SAE hydraulic excavator lift capacity rating standard J1097. They do not exceed 87% of hydraulic lifting capacity or 75% of tipping capacity. Weight of all lifting accessories must be deducted from the above lifting capacities.

Always refer to the appropriate Operation and Maintenance Manual for specific product information.

Mass Boom Lift Capacities



Load Point Height



Load Radius Over Front



Load Radius Over Side



Load at Maximum Reach – Bucket Curled

















Load at Maximum Reach – Bucket Extended

BOOM – 6.18 m (20'3")
STICK – 2.55 m (8'4")

BUCKET – TB 36" HD
with General Duty Tips (x4)
1819.8 kg (4,012 lb)

SHOES – 800 mm (32") triple grouser
UNDERCARRIAGE – Long
HEAVY LIFT – On

	3.0 m (10.0 ft)		4.5 m (15.0 ft)		6.0 m (20.0 ft)		7.5 m (25.0 ft)								
											m ft			m ft	
9.0 m 30.0 ft	kg lb											*4220 *9,400	*4220 *9,400	7.32 23.47	
7.5 m 25.0 ft	kg lb								*5880 *13,050	*5880 *13,050	7.11 23.00	*3900 *8,600	*3900 *8,600	8.65 28.12	
6.0 m 20.0 ft	kg lb				*8030 *17,450	*8030 *17,450	*7460 *16,350	5940 12,650	*5680 *12,550	5060 11,300	8.06 26.27	*3810 *8,400	3750 8,350	9.47 30.93	
4.5 m 15.0 ft	kg lb		*11 540 *24,800	*11 540 *24,800	*9170 *19,850	8710 18,700	*7930 *17,250	5770 12,350	*5750 *12,650	4260 9,450	8.64 28.29	*3860 *8,500	3260 7,200	9.93 32.51	
3.0 m 10.0 ft	kg lb		*14 560 *31,300	12 800 27,650	*10 600 *22,900	8070 17,400	*8640 *18,750	5480 11,750	*6070 *13,350	3860 8,500	8.94 29.32	*4050 *8,900	3030 6,700	10.09 33.09	
1.5 m 5.0 ft	kg lb		*16 800 *36,250	11 620 25,050	*11 870 *25,650	7490 16,100	9080 19,500	5190 11,150	*6640 *14,600	3710 8,200	8.98 29.46	*4390 *9,650	3020 6,650	9.97 32.73	
Ground Line	kg lb		*17 550 *38,000	11 090 23,850	*12 570 *27,200	7110 15,300	8840 19,000	4980 10,700	6850 15,100	3810 8,400	8.76 28.73	*4930 *10,850	3240 7,150	9.57 31.41	
-1.5 m -5.0 ft	kg lb	*15 590 *35,300	*15 590 *35,300	*17 070 *37,000	11 020 23,650	*12 530 *27,050	6970 15,000	8760 18,850	4900 10,550	7530 16,650	4210 9,300	8.26 27.06	*5800 *12,800	3780 8,350	8.85 28.99
-3.0 m -10.0 ft	kg lb	*19 920 *44,150	*19 920 *44,150	*15 480 *33,450	11 230 24,150	*11 510 *24,750	7070 15,200			*8440 *18,600	5110 11,350	7.42 24.25			
-4.5 m -15.0 ft	kg lb	*16 420 *35,200	*16 420 *35,200	*12 240 *26,100	11 750 25,300	*8580 7480									

* Limited by hydraulic capacity rather than tipping load. The above loads are in compliance with SAE hydraulic excavator lift capacity rating standard J1097. They do not exceed 87% of hydraulic lifting capacity or 75% of tipping capacity. Weight of all lifting accessories must be deducted from the above lifting capacities.

Always refer to the appropriate Operation and Maintenance Manual for specific product information.

Standard Equipment

Standard equipment may vary. Consult your Caterpillar dealer for details.

Electrical

- 65 ampere alternator
- Base machine light (frame)
- Lights, cab mounted (Two)
- Horn
- Pre-Start monitoring system – checks for low fluids (engine oil, coolant, hydraulic oil) prior to starting machine

Operator Environment

- Air conditioner, heater, defroster with automatic climate control
- AM/FM radio with antenna and 2 speakers
- Ashtray with 24 volt lighter
- Beverage/cup holder
- Bolt-on Falling Object Guarding System (FOGS) capability
- Cab Glass
 - Openable and retractable two-piece front windshield
 - Sky-light, pop-up, polycarbonate
- Coat hook
- Floor mat
- Instrument panel and gauges
- Joysticks, console mounted, pilot operated
- Light – interior
- Literature compartment
- Monitor, full graphic color display
 - Multi-language capability
 - Warning, filter/fluid change, working hour information, Machine condition, error code, tool mode setting
 - Full time clock on monitor (no less than one week)
- Neutral lever (lock out) for all controls
- Polycarbonate side windows
- Positive filtered ventilation
- Pressurized cab
- Seat, suspension, with high back and head rest
- Seat belt, retractable (76 mm [3 in])
- Storage compartment suitable for lunch box cooler
- Sun shade (for skylight)
- Travel control pedals with removable hand levers
- Windshield wiper and washer (upper and lower)

Engine/Power Train

- C9 with ACERT™ Technology
 - 2300 m (7,500 ft) altitude capability without derate
 - 24V electric starting
 - Air intake heater
 - U.S. EPA Tier 3 emission compliant
 - HEUI™ Injectors
 - Water separator in fuel line
 - Electric priming pump
- Cooling Package
 - High ambient, 52° C (126° F) with VSF
 - Radial seal air filter
 - Automatic engine speed control with one-touch low idle
 - Two speed auto-shift travel
- Undercarriage
 - Grease lubricated track
 - Hydraulic track adjusters
 - Idler and center section track guards
 - Track shoes – 800 mm (32 in) triple grouser
 - Heavy-duty track rollers
- Other Standard Equipment
 - Automatic swing parking brake
 - Auxiliary hydraulic valve
 - Capability of stackable valves (max of 3) for main valve
 - Capability of auxiliary circuit
 - Counterweight with lifting eyes
 - Door locks, cap locks, and Caterpillar® one key security system
 - Fine swing control
 - Fully pressurized hydraulic system
 - Heavy lift
 - Mirrors (frame-right, cab-left)
 - S•O•SSM quick sampling valves for engine and hydraulic oil
 - Travel alarm
 - Wiring provision for Product Link

Optional Equipment

Optional equipment may vary. Consult your Caterpillar dealer for details.

Front linkage

Booms

Reach 6.5 m (21 ft 4 in)

Mass 6.18 m (20 ft 4 in)

Sticks

Reach 3.9 m (12 ft 10 in)

Reach 3.2 m (10 ft 6 in)

Mass 2.55 m (8 ft 5 in)

Bucket Linkage

DB family w/lifting eye

TB1 family w/lifting eye

Boom lowering control device

Electrical

Product Link (PL121SR/PL321SR)

Machine Security System (MSS)

Power supply (12V-10 Amp)

Guarding

Falling Object Guarding System (FOGS)

Front Windshield Guard

Full length, wire mesh

Heavy-duty bottom guards

Rubber bumpers (side)

Track Guiding Guards

Sprocket end, idler end guard two-piece full length
(center guard removed)

Vandalism guards

Operator Environment

Hand control pattern changer (ISO-SAE)

Rear window, secondary exit

Sun screen – roller type

Seat, high back with air suspension and heater

Third pedal, straight travel

Engine/Power Train

Pre-filter, air

Cold Weather Starting Package

Two additional maintenance free batteries

High capacity starter motor

Heavy-duty cable

Jump-start receptacle

Ether aid

Block heater

Undercarriage

Track Shoes

700 mm (28 in) double grouser

700 mm (28 in) triple grouser

850 mm (34 in) triple grouser

850 mm (34 in) heavy-duty triple grouser

Auxiliary Hydraulics

Hammer Circuit

For single function (1 way/2 pump) hydraulic tools

Thumb Circuit

For double function (2 way/1 pump) hydraulic tools

Tool Control System

For single or double function, (1 or 2 way, 1 or 2 pump)
hydraulic tools

Joysticks with additional switches

Program up to 10 tools in memory

Capability of adding medium pressure

Medium Pressure Circuit for tools requiring
medium pressure

Hydraulic pin grabber quick coupler and controller

Lines for booms and sticks

Work Tools

Wide offering of buckets, tips and sidecutters

Notes

330D L Hydraulic Excavator

For more complete information on Cat products, dealer services,
and industry solutions, visit us on the web at www.cat.com

© 2005 Caterpillar
All Rights Reserved
Printed in U.S.A.

Materials and specifications are subject to change without notice.
Featured machines in photos may include additional equipment.
See your Caterpillar dealer for available options.

AEHQ5667 (12-05)

NACD, LACD

CAT, CATERPILLAR, ACERT, their respective logos and "Caterpillar Yellow,"
as well as corporate and product identity used herein, are trademarks
of Caterpillar and may not be used without permission.

CATERPILLAR[®]