



Vredo Selfpropelled Trac

VT3936



Vredo

THE REAL THING!

Vredo brings efficiency; and that is more than a promise



Investment versus return. This is a decision that you have to make – every year, every season. This decision is easily made once you have discovered the Vredo trac. This versatile, robust self-propelled trac offers maximum capacity, speed and employability as the basis for a good return. Thanks to the high pump capacity and the enormous power of the Vredo trac you are assured of a low cost price per hour or per hectare. And, in the long run, this is what matters to you – a good harvest, a satisfied customer and, ultimately, a healthy margin. That is more than a promise. It is everyday practice.





The best filling capacity every day



The tank of your Vredo trac is filled with slurry every day. Therefore, you always have the optimum filling capacity at your disposal. The centrifugal pump, attached to the bottom of the suction arm, has a capacity of 12 m³ per minute. The pump 'pushes' the tank full in no time – the ideal solution when filling the tank from a 4-metre-deep silo. Do you mainly fill the tank at your customer's barn? At 1,400 revs per minute the displacement pump has a capacity of 9 m³. Thus, you can be assured of an optimum filling rate and low fuel costs. This results in a lower cost price per hour and per cubic metre. A Vredo trac gives you an advantage every day.



***Take a seat and
enjoy the rest***



A daily workplace, such as the cabin of the Vredo trac, has to be extremely comfortable. We invite you to experience this. Take a seat in the super luxury Grammer chair and enjoy the rest. You have a 225 degree view of the surrounding area. The practical controls, which are at your fingertips, make this ergonomic workplace complete. From this position you can even fill the tank with the suction arm. It proves that the Vredo trac is intended for intensive use. It is equipped with comfort straight from the heart of the contract workers.



***When every hour counts,
Vredo brings light***

THE REAL THING!



Your working days are not always from sunrise to sunset. On the contrary, Vredo knows how much work you do in the early mornings and late hours. That's why we have equipped the Vredo trac with Xenon lamps as standard. We are literally bringing you light. You can now continue to work without extra effort – safe, efficient and comfortable, day and night.

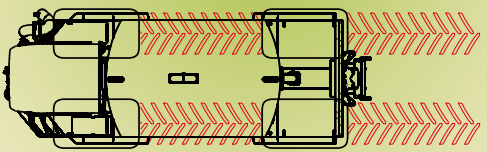
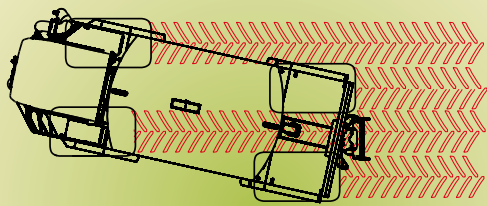

If the soil structure remains intact, your return is not under pressure



Scaling up demands machines with a greater capacity; machines that can do more, but also weigh more. This presents a risk for the soil structure. To achieve a good yield and good financial results, a healthy soil structure is required. In this respect, thanks to the Vredo trac, your performance will not come under pressure. We have taken capacity, weight and tank content to the limit while respecting the structure of the soil and soil life. Each Vredo trac combines high capacity with low soil pressure. The secret? Four large 1050 tyres that enable you to drive with the unique 'dog-walk' system. Each wheel

runs just once over each track. If you wish to have maximum control of the wheel pressure, you can choose the optional tyre pressure changing system. That is typically Vredo.



***Everything you need
and more***



The Vredo trac is certainly practical and efficient. But we have designed the functionality in such a way that even the smallest actions are much simpler. Examples are: the easy volume control, the multifunctional joystick for the driving direction and the operation of the lifting gear, valves and cruise control. You also have a joystick for the operation of the 160 degrees manoeuvrable suction arm. That's why every Vredo has what you need, and more.



Nothing is as relaxing as manoeuvrability

The Vredo trac allows you to access virtually every location. That is the advantage of its remarkably compact body (a length of 7.30) and four-wheel drive. You are manoeuvrable, and that is a nice thought. Difficult manoeuvres in the yard and in the field are definitely a thing of the past. The Vredo can easily make its way to your destination; over small dykes and cow-paths, along fences and between barns. Nothing is as relaxing as manoeuvrability.

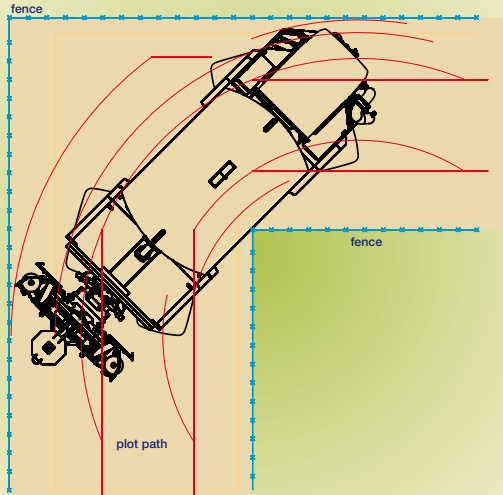
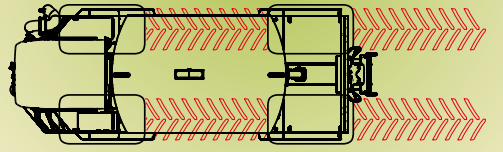
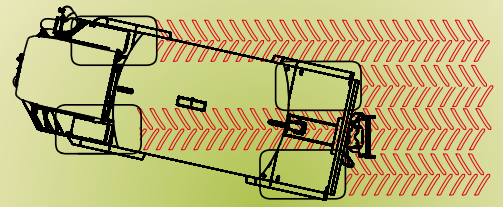

THE REAL THING!

Standard with high specs

Front axle suspension



Xenon lights





Automatic lubrication system

Climate control





Vredo

FINLAND

DENMARK

BELGIUM

GERMANY

FRANCE

SWITZ.

AUSTRIA

Technical information

VT3936

MOTOR

Type	Deutz V6 TIER III TCD 2015V06
Engine Power	408 hp (300 kW)
RPM	1500 rpm (Max. 1900 rpm)
Torque increase	33%
Maximum Torque	2000 Nm @ 1300 rpm

FUEL TANK

500 ltr (+ 300 ltr optional)

TRANSMISSION

Mechanical Driveline, Hydrostatic driven 4 wheeldrive with 100% differential lock, 0-45 km/h stepless, 42 km/h at 1500 rpm

AXLES

Raba type 576
Hydraulically suspended frontaxle (independent)

HYDRAULICS

2 axial plungerpumpen, 60 cc (total 120 cc) Load Sensing
3 Double and single acting valves rear

BRAKES

Wet lamellenbrakes integrated in the axles

REAR LINKAGE

3 point linkage, torsion suspended and steered in dogstyle
Liftpower 7.880 kg , Pushpower 9.680 kg
3 floating positions

- Lifting and lowering double acting
- Lifting and lowering with adjustable pressure

TYRES

Michelin 1050/50 R30.5

CABINE

Suspended cabine, Grammar airsuspended chair, co-driver chair
Climatronic, Radio/CD Player (MP3 and Bluetooth optional)
Elektrically adjustable and heated mirror. Blind Spot mirror.
Camera with LCD screen (in color)
Ergonomical design of operation dashboard

LIGHTS

Xenon Front- en workinglights
2 Warning lights on the cabine and 1 on the tank

MEASUREMENTS

Length:	7.30 mtr.
Width:	3.00 mtr. (2,50 mtr with Michelin 800/65 R32.5)
Hight:	3.70 mtr.
Wheeldistance:	4.50 mtr.
Turning circle:	11.80 mtr. outside circle

WEIGHT

12.080 kg (basic vehicle)

TANK

	19.000 ltr. tank on trac (2400 kg)	25.000 ltr. tanktrailer	25.000 ltr. tanktrailer
Pumpfilterunit	• 9 m ³ displacementpump	15 m ³ centrifugalpump for filling the tanktrailer	9 m ³ displacementpump
	• Vredo Cuttingfilter FT5100H	12 m ³ centrifugalpump for releasing the tanktrailer	Vredo Cuttingfilter FT5100H
	• 1.545 kg	8.100 kg	8.600 kg

Reverse option on slurry pump operated by button in cabin
Filling the tank with reduced rpm
8" suction arm fully electrical-hydraulic operated
Dosing independent of driving speed
pump automatically switches off when tank is full
Automatic lubrication system



Vredo Selfpropelled Trac

VT3936



USER EXPERIENCES:

Agricultural contracting firm v/d Goot from Sondel in Friesland (the Netherlands) rides out an average of 100,000 m³ per year using a Vredo VT3936 19000V and chooses Vredo for the following reasons:

Petrus van de Goot (owner of 2 Vredo self propelled tracs):

"The Vredo VT3936 is a machine with an unrivalled capacity and manoeuvrability. Thanks in part to its crab-steering, this machine has an incredibly low ground pressure. We have very positive experiences with the perfect continual development of the machines in the 10 years that we have been using Vredo tracs and the excellent service Vredo provides. So once you go Vredo, you won't go back!"

Agrarservice Wimmer from Marktelt (Germany) with 50,000 m³ slurry per year chooses Vredo for the following reasons:

Thomas Wimmer (owner, Vredo VT3936 19000V):

"Vredo machine are perfectly thought through with an exceptional stability and more than sufficient power which is an absolute requirement in mountainous terrain. The Vredo's turning circle is extremely compact because of the 4-wheel drive. All these advantages allow the machine to provide marvellous work, which is what it is all about in the end"

Varde Maskinstation Ambh from Varde (Denmark) with 110,000 m³ slurry per year and extra activities in corn chooses Vredo for the following reasons:

Anker Vestergaard (manager, Vredo VT3936 with 25000V Tank trailer):

"At the time we chose Vredo, we compared it with several combinations and of course also with a tractor with a 25 m³ tank. Vredo was far superior in this comparison regarding capacity. But Vredo also stood out in regards to the quality of the ride with the sprung front axle and the minimal motor noise in the cabin. The end result is that Varde Maskinstation is attracting more and more customers in part thanks to the crab-steering and the excellent manoeuvrability!!"

Koneurakointi kreus ay from Kannus (Finland) with 60,000 m³ slurry per year chooses Vredo for the following reasons:

Marko Kreus (owner, Vredo VT3326 15000V):

"Vredo is the machine that is suitable for all types of land. Wet or dry, we can always do our job, the results are excellent, and the customer service in Finland is perfect. This is why Vredo was our choice."

dealer:

Vredo

Vredo Dodewaard B.V.

Welysestraat 25a

6669 DJ Dodewaard (NL)

Postbus 35

6670 AA Zetten (NL)

t +31(0)488 411 254

f +31(0)488 412 471

e info@vredo.nl

i www.vredo.com