

M315C

Wheel Excavator



Cat® 3054E DIT ATAAC diesel engine

Net power (ISO 9249) at 2000 rpm

91 kW/124 hp

Operating Weight

15 000 to 16 650 kg

Bucket Capacities

0.26 to 0.91 m³

Maximum Reach at Ground Level

9380 mm

Maximum Digging Depth

6070 mm

Maximum Travel Speed

34 km/h

M315C Wheel Excavator

The C Series incorporates innovations for improved performance and versatility.

Engine

The new Cat 3054E DIT ATAAC electronically controlled engine provides increased horsepower to serve the advanced hydraulic system. Performance, reliability, durability, excellent fuel economy, and low sound levels help maximize working efficiency. The innovative cooling system is easy to clean and features increased cooling capacity through a temperature sensing on-demand fan. **pg. 4**

A Step Ahead in Environmental Considerations

Helping to protect our environment, the engine has low operator and spectator sound levels. In addition the hydraulic system can be operated with biodegradable oil. Longer filter change intervals and more fuel efficiency also help reduce impact on our environment. **pg. 6**

Ease of Operation and Enhanced Productivity

The new Joystick Steering allows the operator both to work with implements and maneuver the machine without using the steering wheel. This provides significant improvement in operator comfort and productivity. **pg. 7**

Hydraulics

The hydraulic system, featuring a separate swing pump and load-sensing system, provides maximum power and exceptional controllability leading to high performance in all applications. The technologically advanced tool control option adds work tool flexibility to the hydraulic system. Proportional medium pressure function allows improved control of attachments and work tools. The new adjustable hydraulic sensitivity allows adjustment of attachments in order to find the best setup for any application. This ensures both improved productivity and greater operator comfort. **pg. 5**

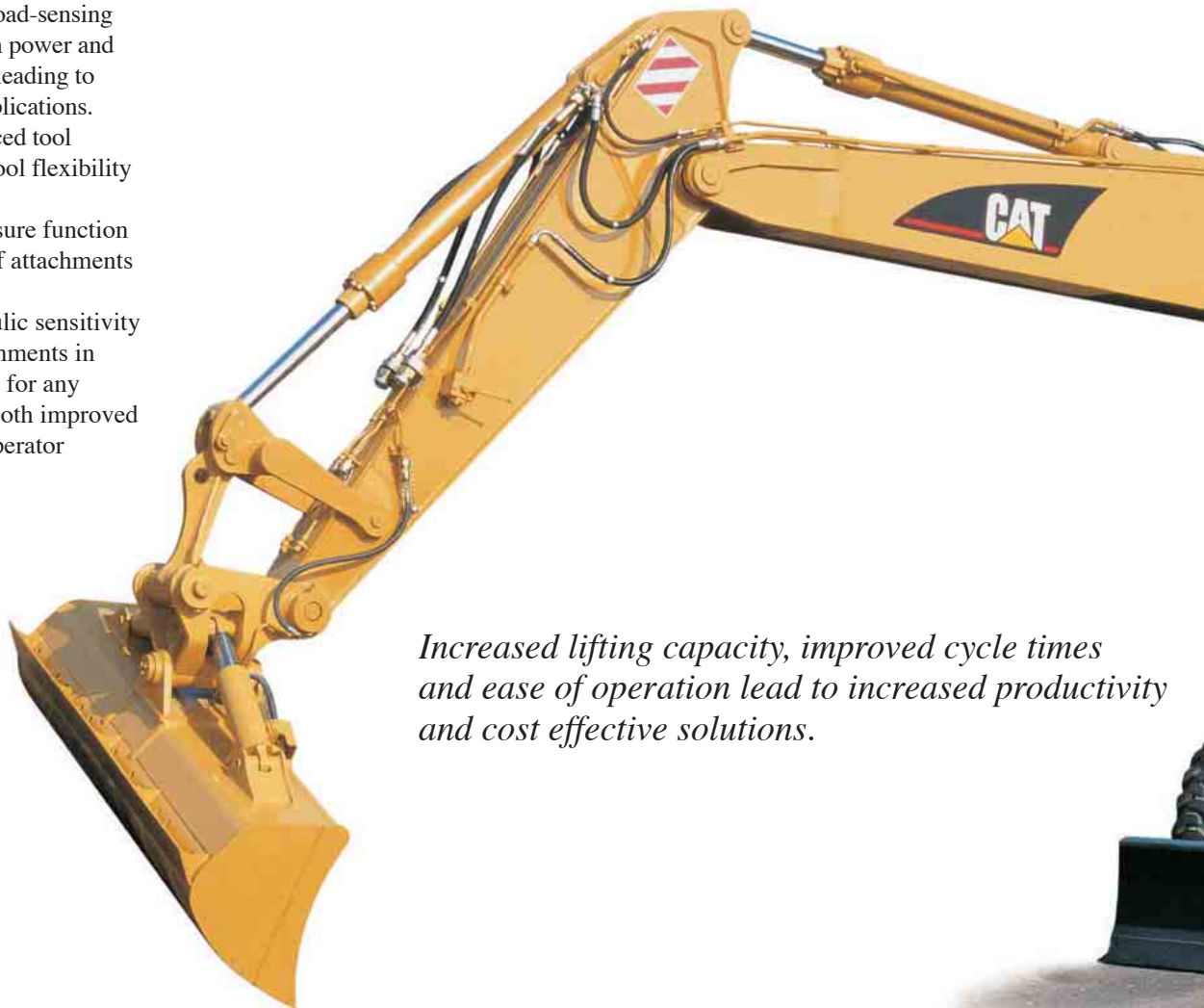

Increased lifting capacity, improved cycle times and ease of operation lead to increased productivity and cost effective solutions.

Operator Comfort

The new operator station design maximizes operator comfort and visibility. A new comfort seat with air suspension (optional), ergonomic joysticks, a new soft switch panel and the WEX Multipro monitor are some of the features that help allow the operator to work free of fatigue and so remain attentive to the job in hand. The operator station also offers more space to the side and the front and features automatic climate control.
pg. 8

Undercarriage and Drive Train

Pin-On design of outriggers and dozer blade allows for interchangeability and helps increase flexibility to match the application requirements. Heavy-duty cylinder protection and box section design help provide excellent life. Updated drive line, new axles, travel motor and transmission control provide smooth travel. Improved hydraulic braking forces and advanced gear shifting give better controllability.
pg. 10

Booms and Sticks

The box section design of all front-end structures, together with the optimum balance of durability and weight provide the strength needed for even the toughest application. Multiple boom and stick options allow you to pick the best match for your job. **pg. 11**

Buckets and Teeth

A wide variety of bucket types are available for the M300 C-Series. These aggressive bucket designs are matched to fit the high C-Series digging forces to improve productivity.
pg. 12

Work Tools

Buckets, grapples, hammers, and quick couplers provide a total solution package to the end-user. Built for performance and durability these tools deliver high productivity, long service life and excellent value. **pg. 13**

Maintenance and Reliability

All daily maintenance points, such as oil level and greasing ports, are accessible from ground level. A centralized greasing system allows the operator to grease the front linkage and swing bearing without climbing onto the machine. The oscillation axle is equipped and the dozer blade can be ordered for remote greasing. This is both convenient and reduces service. **pg. 14**

Complete Customer Service

Your Cat dealer offers a wide range of services that can be set up under a customer support agreement when you purchase your equipment. The dealer will help you choose a plan that can cover everything from machine and attachment selection to replacement.
pg. 17



Cat 3054E DIT ATAAC Engine

The four-cylinder, turbocharged, air-to-air aftercooled and electronically controlled engine is built for power, reliability, low maintenance, excellent fuel economy and low emissions.



Powerful Performance. The 3054E DIT ATAAC engine delivers a net power of 91 kW (124 hp) at the rated speed of 2000 rpm, and meets all current worldwide emission standards.

Turbocharged and Air-to-Air Aftercooled. The turbocharger packs more dense air into the cylinders for more complete combustion and lower emission improving performance and engine efficiency. These benefits are especially useful at high altitudes. The air-to-air aftercooler reduces smoke and emissions by providing a cooler inlet air for more efficient combustion. This also extends the life of the piston rings and engine bore.

Cooling System. Features an electronically controlled variable speed on-demand fan. A hydraulic motor drives the fan and its speed is determined by engine coolant and hydraulic oil. Cooler operating conditions allow lower average fan speeds resulting in reduced fuel consumption and lower noise levels. The electronic engine control continuously compensates for this varying fan load, providing consistent net horsepower, regardless of operating conditions. The fan and air conditioner condenser are both hinged for easier cleaning of the cores.

Engine Oil. Caterpillar engine oil is formulated to optimize engine life and performance and is strongly recommended for use in Cat diesel engines. The engine oil change interval is increased to 500 hours.

Low Sound, Low Vibration.

The 3054E design improves operator comfort by reducing sound and vibration. The M315C has been awarded the German Blue Angel for low operator and spectator sound levels.

- Operator sound level, L_{PA} , 71 dB(A)
- Spectator sound level, L_{WA} 101 dB(A)

Factory Remanufactured Parts. A large choice of factory remanufactured parts and dealer proposed repair options increase machine availability and reduce total repair costs.

Fuel Injection Pump. The new injection pump is electronically controlled and helps to reduce fuel consumption.

Service. The engine is longitudinally mounted on the right side to make it easier to access the oil filter, oil filler, oil drain valve, fuel filter, V-belt tightener, and the oil dipstick. All are accessible from ground level.

Hydraulics

Fast cycle times, increased lift capacity and high bucket and stick forces combine to maximize your productivity in any job.

Automatic Engine Control. Automatic Engine Control (AEC) reduces engine rpm if no operation is performed, maximizing fuel efficiency and reducing sound levels.

Dedicated Swing Pump. A separate dedicated variable displacement piston pump and fixed displacement piston motor power the swing mechanism. This closed hydraulic circuit helps to provide maximum swing performance without reducing power to the main hydraulic functions.

Caterpillar's XT-6 ES Hoses. To meet the critical flexibility and strength demands of wheel excavator applications, XT-6 ES hoses are installed in the high pressure hydraulic system. XT-6 ES hoses are made of four overlapping insulated wire spiral wraps bonded together for high abrasion resistance, excellent flexibility and easy installation. Hose routings are designed to protect from damage in this way reducing hose failure downtime. O-ring face seal couplings provide positive sealing for reliable and leak-free connections.

Auxiliary Hydraulic Valves. The versatility of the hydraulic system can be expanded with multiple valve options.

Multifunction Valve. The multifunction valve is the core of the innovative Tool Control system. This valve can be electronically programmed for flow direction (one or two ways), pressure and flow rate. The valve also features priority flow to maximize control of the work tool. This on-board electro-hydraulic functionality eliminates the need for manual readjustments to the auxiliary hydraulics each time a different tool is used.

Hammer. The dedicated hammer valve is the best option for machines which will only require a hammer tool and do not need the flexibility provided by the multifunction valve.



Hydraulic Cylinder Snubbers.

The hydraulic cylinder snubbers at the rod end of boom cylinders, both ends of stick cylinders and bucket cylinder rod end cushion shocks, reduce sound and increase cylinder life, keeping the machine working longer.

Caterpillar® Hydraulic Oil.

Maximum protection against mechanical and corrosive wear in all hydraulic systems. Its high zinc content reduces wear and extends pump life. Provided certain requirements are met (e.g. S•O•S analysis every 500 hours), the hydraulic oil change interval is extended from 2000 hours to 4000 hours.

Controllability. The hydraulic system offers precise control of the M315C, reducing operator fatigue and improving effectiveness.

Stick Regeneration Circuit. Stick regeneration circuits increase efficiency and help increase controllability for higher productivity and lower operating costs.



Adjustable Hydraulic Sensitivity.

It allows the operator to adjust the aggressiveness of the machine according to needs. For precision work, one of four different levels of aggressiveness can be pre-selected on the soft-switch panel. Increased sensitivity can then be quickly activated and deactivated during the work cycle by using the joysticks.

Proportional Medium Pressure.

The unique Cat proportional sliding switches provide modulation to the medium pressure circuit and better control for attachments and work tools. They are ideal for tilting buckets and rotating tools. They enable the operator to select exactly how much movement is required and subsequently vary this throughout the operation.

Environmentally Responsible Design

Caterpillar machines not only help you build a better world, they help maintain and preserve the fragile environment.



More Performance. The M315C is designed for outstanding performance with high fuel efficiency. This means more work done in a day, less fuel consumed and minimal impact on our environment.

Low Exhaust Emissions. The Cat 3054E used in the M315C is a low emission engine designed to meet EU Stage II Off-Highway and US EPA Tier II emission regulations.

Quiet Operation. The noise level inside the cab and as well the outside spectator sound are extremely low. As a result of the new variable speed fan and remote cooling system all machines meet the German Blue Angel award for low sound operation.

Ozone Protection. To help protect the earth's ozone layer, the M315C's air conditioning unit uses only R-134a refrigerant which does not contain harmful chlorofluorocarbons (CFC's).

Biodegradable Hydraulic Oil.

Available as an option, Caterpillar Biodegradable Hydraulic Oil (HEES™) is formulated from a fully saturated Hydraulic Environmental with Ester Synthetic base stock and selected additives. It has excellent high-pressure and high-temperature characteristics and is fully compatible with our hydraulic components and allows operation over a broad temperature range. Cat's HEES is fully decomposed by soil or water microorganisms, providing a more environmentally-sound alternative to mineral-based oils. This is available as an attachment.

Fewer Leaks and Spills. Lubricant fillers and drains are designed to minimize spills. Cat O-Ring Face Seals, XT Hose and hydraulic cylinders are all designed to help prevent fluid leaks that can reduce the machine performance and cause harm to the environment.

Longer Service Intervals. 500-hour engine service intervals and Cat Extended Life Coolant/Antifreeze mean that fluid renewal and disposal are less frequent.

Ease of Operation and Enhanced Productivity

Designed for simple, easy operation, the M315C allows the operator to focus on production.



WEX Multipro. New, compact Multipro enhances viewing while displaying a variety of easy-to-read and understandable information in various languages.

Pre-start WEX Multipro System.

The Pre-start Multipro system alerts the operator of low coolant or hydraulic oil levels, before starting the engine. When the engine key remains in the “ON” position for more than 2 seconds, a warning indicator and message are displayed if actual fluid levels are lower than required.

Filter and Oil Change Warnings.

The filter and oil change warnings are displayed when the number of hours used reaches the maintenance interval.

Languages. 23 different languages are available on the M315C.

Power Modes. There are three power mode settings. The operator can choose the best power setting for both engine and hydraulic power versus fuel efficiency.

Economy Mode. The economy mode is often used for lifting, pipe setting, grading, slope finishing and precise work. This mode helps ensure minimum fuel consumption.

Power Mode. This mode is used for normal truck loading and digging applications, trenching or hammer use.

Travel Mode. The travel mode is automatically set when the travel pedal is actuated. It provides maximum speed and drawbar pull.

Integrated Tool Control System.

The integrated Tool Control system allows the operator to quickly select a tool out of five pre-set combinations, eliminating the need to reset these hydraulic parameters each time a tool is changed. Specific flow and pressure can be programmed easily as well as one-way/two-way hydraulic functions. Each of the five programmed tools can even be given a specific name.

Joystick Steering. It allows the operator to reposition the machine in the first gear and work simultaneously with the implements, keeping both hands on the joysticks. The operator is able to do more precise work in a shorter amount of time. This provides increased safety for all people working around the machine by removing the need for the operator to move their hands back to the steering wheel for maneuvering.

All-day operator comfort

The M315C interior layout maximizes operator space, provides exceptional comfort and reduces operator fatigue.





Interior Operator Station. The M315C operator work station is quiet, controls have been placed conveniently for easy adjustment and ease of operation. The seat design is ergonomic and ventilation is highly effective.

Seat. The wheel excavator seat with two-tone color design offers adjustable back rest, lumbar support, cushion length and cushion angle. Independently adjustable armrests and pilot controls allow tailored ergonomics to suit operator preference. Optional Comfort seat provides air suspension, seat heating, horizontal suspension and automatic adjustment for the operator's weight to help maximize comfort.



Consoles. Designed for simplicity and functionality, the left side console is tiltable for excellent access to the cab. Dozer blade and/or outrigger controls as well as the radio-off switch are located on the left console.



Automatic Climate Control. Fully automatic climate control adjusts temperature and air flow.

Greater Control Convenience. Each control is placed within easy reach of the operator. Joysticks control all attachments and swing functions and can also be used to steer the machine and to activate the adjustable hydraulic sensitivity. By means of the soft switch panel, which is placed to be easily reached, the operator controls the oscillating axle, power modes, parking brake, automatic engine speed control and other hydraulic functions.



Cab Mounts. The cab shell is attached to the frame with resilient mounts, reducing vibration and sound.



Foot Pedals. Two-way pedals for the travel and auxiliary circuits give more floor space and reduce the need to change positions. The foot pedal for the auxiliary high-pressure circuit can now be locked in the off position to be used as a footrest for greater operator comfort.



Skylight. A unique large polycarbonate skylight provides excellent upward visibility.

Viewing Area. There is excellent viewing area through wide windows. The lower of the two-piece window can be opened separately for better air ventilation or be slid into the upper window to completely open the front bay. An optional one-piece window is available.

Wipers. Designed to maximize visibility in poor weather conditions. The parallel wiper system covers almost the complete front window without leaving unwiped areas in the immediate line of sight of the operator.

Large Storage Compartment. Located behind the seat, provides sufficient room. An optional cover is available to close off the storage space if preferred.

Easy Access. Conveniently located grab irons and large steps mounted to the undercarriage, together with the tiltable steering column and the tiltable left side console, provide easy access to the cab.

Undercarriage and Drive Line

Undercarriage and axle design provides maximum strength, flexibility and mobility on wheels.

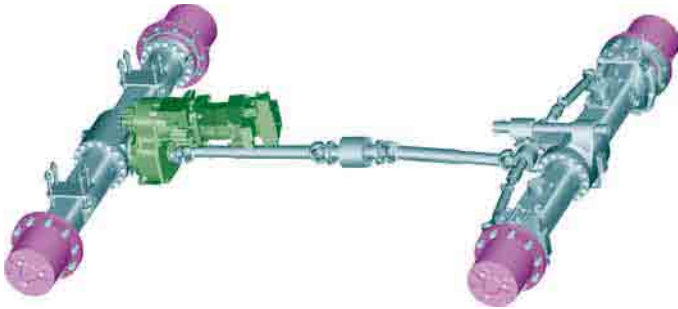

Strong Undercarriage. The welded frame provides excellent rigidity and long life. Efficient hydraulic lines routing, transmission protection and heavy-duty axles make the undercarriage perfect for wheel excavator applications. Both outriggers and dozer blade are pin-on for maximum flexibility.

New Drive Line Concept. The new travel motor and transmission control in the drive line provide more comfortable travel due to increased smoothness, improved hydraulic braking and improved gear shifting.

Travel Motor. The advanced travel motor gives higher hydraulic braking forces particularly in downhill roading by continuously using the optimal displacement of the travel motor for braking. Braking characteristics can be adjusted to the operator's preferred level of aggressiveness in three steps.

Transmission Control. The intelligent implementation of the engine torque curves in an optimized gear shifting process reduces uphill travel time, particularly in hilly areas.

Heavy Duty Axles. The front axle offers great oscillating and steering angles. The transmission is mounted directly on the rear axle for protection and optimum ground clearance.

Advanced Disc Brake System. The new disc brake system acts directly on the hub instead of the drive shaft to avoid planetary gear backlash. This technical solution eliminates the rocking effect associated with working free on wheels. The new axle is designed for low maintenance and lifetime costs. Oil change intervals are increased from 1000 up to 2000 working hours in order to further reduce owner and operator costs.

Outriggers. Recommended for maximum operating stability when digging and lifting, the outriggers can be individually controlled to level the machine on slopes. Featuring pin-on design, heavy-duty cylinder guards, and optimized kinematics, the outriggers can be mounted on the front, rear or on both ends of the machine.

Dozer Blade. A useful addition for leveling and clean-up work, it can also be used to stabilize the machine during digging applications. The large dozer floor and the parallel design provide minimal ground pressure reducing impact to the work surface. Featuring a pin-on design, heavy-duty cylinder guards, and optimized kinematics, the dozer blade can be mounted either on the front or the rear end.

Tool Box. A large sealed and lockable toolbox is mounted on the undercarriage between the steps on the machine's left side. A second optional toolbox is available for the right side.

Booms and Sticks

Improved strength and kinematics help to bring higher production and efficiency to all jobs.

Booms and Sticks. Built for performance and long service life, Caterpillar booms and sticks are large, welded, box-section structures with thick, multi-plate fabrications in high-stress areas.

Flexibility. The choice of three booms and four different sticks means that the M315C offers the right combination of reach and digging forces for all applications.

Hydraulically Adjustable Boom (VA).

The VA boom (5200 mm) offers improved visibility and machine roading balance. When working in tight quarters or lifting heavy loads, the VA boom offers the best flexibility.

One-piece Boom.

The one-piece boom (5050 mm) fits best for all standard applications such as truck loading and digging. A unique straight section in the curve of the side plate reduces stress flow and helps increase boom life.

Offset Boom. The offset boom (5200 mm) adds a major advantage and a high level of versatility to the machine, as the large offset dimensions (left/right 2460/2760 mm) allow you to dig along walls, over obstacles, to grade while driving, and to dig under laid tubes without damaging them. The combination with a tiltable ditch cleaning bucket lets you operate a highly versatile system.

Sticks. Four different stick lengths are offered to match different applications.

- **Short stick** (2100 mm) for maximum breakout force and lifting capability
- **Medium stick** (2400 mm) as standard for most applications
- **Long stick** (2600 mm) to match reach and depth requirements
- **Industrial stick** (3100 mm) for use with free swinging grapples in material handling and industrial applications



Buckets and Teeth

A wide variety of buckets help optimize machine performance. Purpose designed and built to Caterpillar's high durability standards.

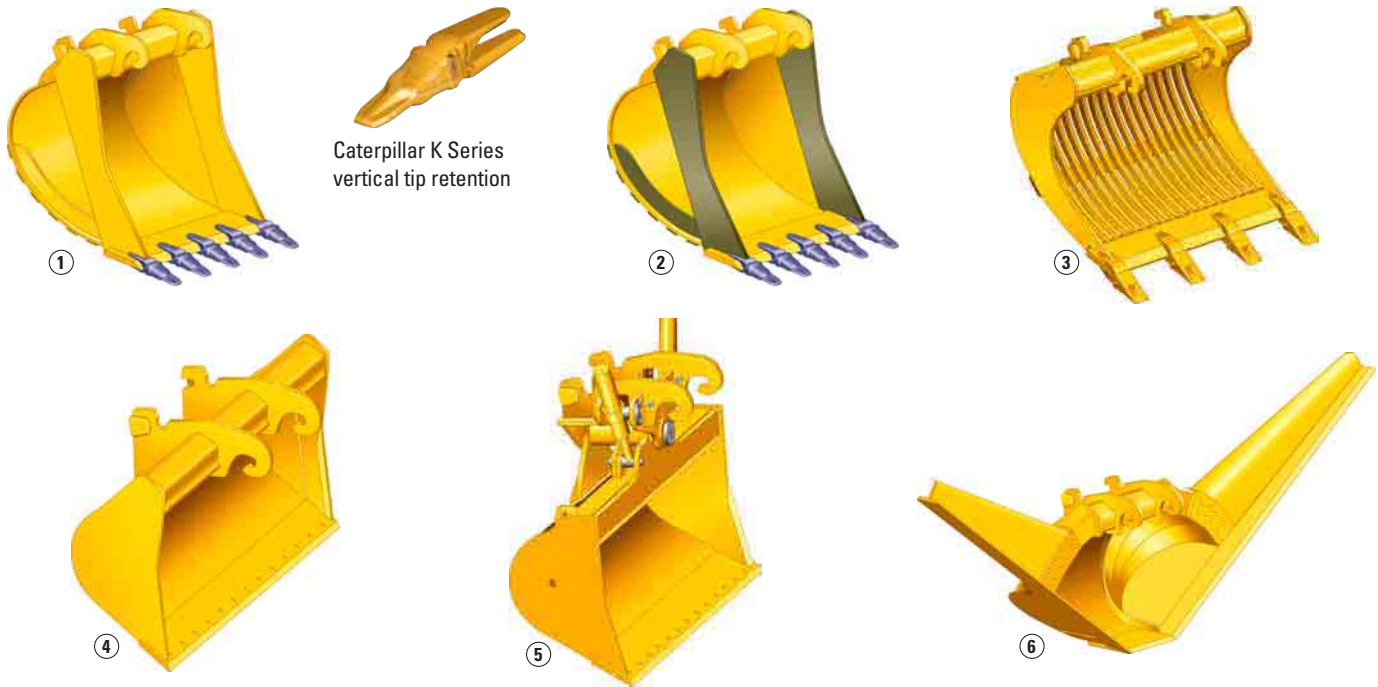

Caterpillar K Series vertical tip retention

Caterpillar K Series™ Tooth System



1 Excavation Bucket. Digs and loads soft to medium materials such as clay and earth. Features weld on tip adapters, hardened cutting edge and side bars.

2 Extreme Excavation Bucket. Digs and loads compact/abrasive materials like earth/rock, sand/clay, sand/gravel, coal, chalk and low abrasion ores. Features abrasion resistant steel for all wear parts.

3 Skeleton Bucket. For soft and moist soils and for applications where separation of materials, e.g., branches, peat moss, is required and for breaking up asphalt.

Heavy Duty Skeleton Bucket. As standard skeleton bucket, but for more demanding applications such as sorting rock from sand or gravel on demolition sites.

4 Ditch Cleaning Bucket. Wide, light bucket used mainly with long reach configurations to clean waterbeds and banks.

5 Tiltable Ditch Cleaning Bucket. Wide, light hydraulically tilttable bucket for ditch cleaning and slope finishing applications.

6 Trapezoidal Bucket. To prepare and maintain small irrigation ditches. Features angled sides to shape ditch banks in one operation. Optionally available with mechanically adjustable side angles.

Pin-on version and Quick Couplers. All Cat buckets are available in both quick coupler and pin-on version.

Tip Selection. The new Caterpillar K Series Tooth System holds tighter, changes easier and stays sharper.

10 General Duty

11 Extra Duty

12 Penetration

13 Penetration Plus

14 Heavy Penetration

15 Heavy Abrasion

16 Wide

17 Spike

18 Double Spike

Tool Control System, Quick Couplers and Work Tools

User-friendly, integrated electro-hydraulics make changing tools easy and quick and allow the operator to focus on efficient work.

Tool Control. Five hydraulic pump flow and pressure settings can be preset on the Multipro, eliminating the need to adjust the hydraulics each time a tool is changed. Selecting the proper setting from the Multipro's menu instantly provides the operator with the correct amount of flow and pressure for the tool. The unique Cat proportional sliding switches provide modulation to the tool and make precision work easy.

Quick Couplers. Caterpillar Quick Couplers enable the operator to simply release one work tool and pick up another. Your hydraulic excavator becomes highly versatile. To suit your business and application needs, Caterpillar offers two different types of Quick Couplers.

CW-Series Dedicated Quick Coupler. The dedicated CW-Series quick coupler enables a quick tool exchange while maintaining top machine performance. It is available in a hydraulic and spindle version.

- The hydraulic version is available in a standard and a narrow version and makes it very easy for the operator to switch tools without having to leave the cab.
- The spindle version is a user-friendly mechanical version that can later be easily converted into the hydraulic version if required. The spindle version is also available in the narrow and standard version.
- A lifting hook is added to the dedicated quick coupler for maximum lift capacity.



A quick coupler hydraulic circuit for this CW-Series coupler is available factory installed.

Pin Grabber Plus Quick Coupler. This hydraulically controlled Pin Grabber Plus quick coupler makes changing buckets and other popular work tools simple and fast. The Pin Grabber Plus coupler mounts to the end of the stick and allows buckets, clamshells and other work tools to be used with little or no modification.

- Each model fully adjusts to different pin spreads of various tools regardless of manufacturer – it is the only coupler that accommodates a wide range of work tool makes and models.
- Pin-on assembly makes coupler installation and removal fast and easy.
- Coupler retains the same bucket opening and closing angles.
- Buckets can be reversed for greater flexibility when working around and under obstructions.
- Integrated lift eye.

Pin Grabber Plus quick coupler hydraulic circuit for wheeled excavators is available as a retrofit kit dedicated to this coupler. Ask your Cat dealer for more specific information.



Multi-Processor. The Caterpillar Multi-Processors can be equipped with different jaw types depending on your need.

- CC-jaws combi cutter.
- CR-jaws concrete crusher.
- PP-jaws primary pulverizer.
- PS-jaws secondary pulverizer.
- S-jaws steel.

Multi-Grapple. The Multi-Grapple with unlimited left and right rotation is the ideal tool for stripping, sorting, handling and loading.

Orange Peel Grapple. Specifically designed for handling scrap and rock in recycling and transfer applications.

Clamshell. For some trenching applications or jobs being performed on inner city roads, a clamshell provides an ideal solution. The free-swinging tool makes it possible to dig small sized holes easily.

Hammer. With their wide variety of tools, Cat hammers provide the perfect match for maximum life, efficiency and productivity.

Maximum Uptime – Service and Maintenance

Extended service intervals and easy access reduce operating costs.



Extended Service Intervals. M315C service and maintenance intervals have been extended to reduce machine service time, increase machine availability and reduce operating costs. Using S•O•S hydraulic oil change intervals can be extended from 2000 hours to 4000 hours. Engine coolant change intervals are up to 12 000 hours with using Cat Extended Life Coolant/Anti-Freeze.

Easy, Wide Open Access. Gull-wing doors with pneumatically assisted lift cylinders lift up effortlessly for excellent access to the engine and to all service points. An additional toolbox located under the step leading to the upper platform offers clean, dry space for the operator.

Storage Box. The upperstructure access incorporates a sealed and lockable storage box for personal belongings of the operator.

Easy to Clean Coolers. Flat fins on all coolers reduce clogging and make it easier to remove debris.

Ground Level Service. The design and layout of the M315C was made with the service technician in mind. The fuel water separator, engine oil filter, battery, radiator fluid level, fuel filter, engine oil gauge, hydraulic oil level, air cleaner and pilot system filter are all easily accessible at ground level allowing critical maintenance to be done quickly and efficiently.

Front Compartment. The front service compartment provides ground level access to the batteries, ATAAC, AC condenser and the air filter.

Swing-Up AC Condenser. Without using tools, the AC condenser swings up vertically to allow cleaning on both sides as well as clear access to the ATAAC.

Fuel Tank Drain. Located at the bottom of the upper frame, the fuel tank drain with a hose connection allows simple, spill free fluid draining.

Air Filter. Caterpillar Radial Seal air filters do not require tools to service them, thus reducing maintenance time. The air filter features a double-element construction and built-in precleaner for superior cleaning efficiency. When the air cleaner plugs, a warning is displayed on the monitor screen inside the cab.

Capsule Filter. The hydraulic return filter, a capsule filter, is situated inside the hydraulic tank. This filter prevents contaminants from entering the system when hydraulic oil is changed and keeps the operation clean.

Engine Inspection. The engine can be accessed from both ground level and from the upper structure. The longitudinal layout ensures that all daily inspection items can be accessed from ground level. The engine and pump compartment are separated by a steel wall.

Water Separator. The water separator removes water from fuel even when under pressure and is located in the engine compartment.



Handrails and Steps. Well-sized handrails and steps assist the operator in climbing on and off of the machine.

Diagnostics and Monitoring.

The M315C is equipped with S•O•S sampling ports for the hydraulic system and engine oil. A connection for the Electronic Technician (ET) is conveniently located in the cab.

Anti-Skid “Punched-Star” Plate.

An anti-skid punched-star plate covers the top of the steps and the upper structure to prevent slipping during maintenance.

Electronic Technician (ET).

The electronic engine and machine controllers provide detailed diagnostic possibility for service technicians. The ability to store both active and intermittent indicators simplifies problem diagnosis and reduces total repair time, resulting in improved machine availability and lower operating cost. ET can be used to...

- access data stored in the engine and transmission controls via the Cat Data Link System
- display the status of parameters such as engine speed, gear engaged, control switch position, etc.
- view active and non-active diagnostic codes and clear them after repair
- perform diagnostic tests and calibrations of electro-hydraulic components
- view current configuration and change parameter settings
- flash new Caterpillar software into the Electronic Control Modules

A customer version of ET is also available for your fleet of Caterpillar equipment. Contact your Caterpillar dealer.

Scheduled Oil Sampling (S•O•S)

Analysis. Caterpillar has specially developed S•O•S to help ensure better performance, longer life and increased customer satisfaction. It is a thorough and reliable early warning system which detects traces of metals, dirt and other contaminants in your engine, axle and hydraulic oil. It can predict potential trouble early, thus avoiding costly failures. Your Caterpillar dealer can give you results and specific recommendations shortly after receiving your sample. Each S•O•S test can provide specific types of diagnosis:

- **Oil condition analysis** identifies loss of lubricating properties by quantifying combustion products such as soot, sulfur, oxidation and nitrates.
- **Wear analysis** monitors component wear by detecting, identifying and assessing the amount and type of metal wear elements found in the oil.
- **Chemical and physical test** detect the physical presence of unwanted fluids (water, fuel, antifreeze).

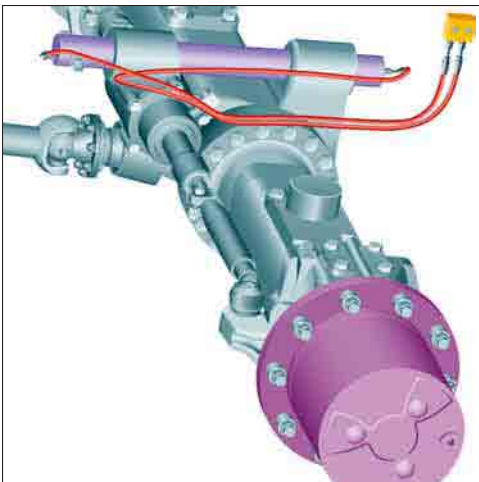

Remote Greasing Block. A greasing block is located in the engine compartment on the upper carriage, with two grease points for the swing bearing and one for the front end attachment. This delivers grease to hard-to-reach locations. For the lower undercarriage, two remote blocks give easy access for greasing to the oscillating axle and, as an option, the dozer blade.

Hydraulic Tank Drain. The hydraulic tank drain enables simple, spill-free fluid changes.

Lower Operating Costs

Improvements in operating costs provide a long-term investment.



Fuel Consumption. The new EU Stage II and US EPA Tier II, electronically controlled engine, new fuel injection system and new ATAAC combine to provide outstanding fuel consumption during both production and traveling. The Automatic Engine Speed Control reduces idle speed when the implements are not active to further improve fuel consumption.

Filter Change Intervals. 2000 hours hydraulic oil and 500 hours engine oil filter change intervals save time and money.

Hydraulic Oil Change Intervals. With the aid of S•O•S sampling hydraulic oil change intervals can be extended from 2000 hours to an average of 4000 hours.

Rebuildable Components. Many of the major components used in the M315C are designed for re-manufacturing. This means you have high-quality, certified rebuilt replacement parts available at a fraction of the cost of new parts. There is less scrap for disposal.

Your Caterpillar dealer can provide you with detailed calculations and simulations of how our low operating costs can benefit your particular application.

Maximum uptime – Reliability

Caterpillar standard features help to increase machine uptime.

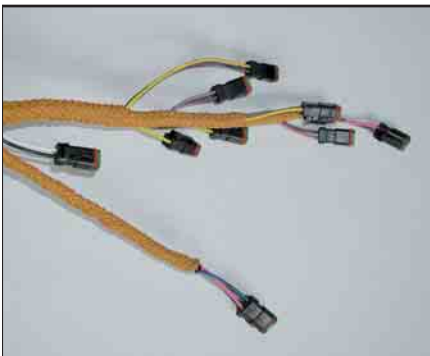

Caterpillar Braided Harnesses. Designed and manufactured to resist the most severe conditions. Harnesses are made of large section, colored and number-coded wires with the complete harness being protected by an abrasion resistant braiding. Harnesses are properly routed and securely clamped to ensure their reliability and life.

XT-6 ES Hoses. Premium quality rubber, precision 4-ply wire reinforcement and exclusive reusable couplings are all unique features of Cat hoses which deliver top performance and long life. O-Ring face seals provide positive sealing for reliable and leak-free connections.

Caterpillar Batteries. Caterpillar maintenance-free, high output batteries are designed for high cranking power and maximum protection against vibration.

Fuel Filters. Cat high efficiency fuel filters with a Stay-Clean Valve™ feature cellulose/synthetic blend media that remove more than 98 percent of particles that are two microns or larger, increasing fuel injector life.

Complete Customer Support

Cat dealer services help you operating longer with lower costs.

Services. Customer Service is critical today in every business. That's why so many people buy Cat equipment. They know they are getting quality reliability and performance backed-up with the best Customer Service. Your Caterpillar dealer offers a wide range of services that can be set up under a Customer Support Agreement. The dealer will help you choose a plan that can cover the whole machine including work tools, to help you getting the best out of your investment.

Product Support. You will find a solution for your parts requirements at your dealer. Cat dealers utilize a worldwide network to find in-stock parts to minimize downtime. In addition your dealer can offer alternative solutions like Reman, Classic Parts and quality used parts to save money on original Caterpillar components.

Service Capability. Whether in the dealer's fully equipped shop or in the field, you will get highly trained service technicians using the latest technology and tools.

Maintenance. More and more equipment buyers are planning for effective maintenance before buying equipment. Choose from your dealer's wide range of maintenance services at the time you purchase your machine. Repair option programs guarantee the cost of repairs up front. Diagnostic programs such as S•O•S Fluid Analysis and Technical Analysis help you avoid unscheduled repairs.



Selection. Make detailed comparisons of the machines you are considering before you buy. How long do components last? What is the cost of preventive maintenance? Your Cat dealer can give you precise answers to these questions to make sure you operate your machines at the lowest cost.

Purchase. Consider the financing options available as well as day-to-day operating costs. This is also the time to look at dealer services that can be included in the cost of the machine to yield lower equipment and owning and operating costs over the long run.

Operation. Improving operating techniques can boost your profits. Your Cat dealer has training material and ideas to help you increase productivity.

Replacement. Repair, rebuild or replace? Your Cat dealer can help you evaluate the cost involved so you can make the right choice.

Engine

Cat 3054E DIT ATAAC diesel engine	
Ratings	2000 rpm
Net power	
ISO 9249	91 kW/124 hp
EEC 80/1269	91 kW/124 hp
Bore	105 mm
Stroke	127 mm
Displacement	4.4 liters
Cylinders	4
Maximum torque at 1400 rpm	500 Nm

- All engine horsepower (hp) are metric including front page.
- The 3054E engine meets EU directive 97/68/EC Stage II emission requirements.
- Net power advertised is the power available at the flywheel when the engine is equipped with fan, air cleaner, muffler, and alternator.
- No engine derating is required below 3000 m altitude.

Swing Mechanism

Swing speed	10.5 rpm
Swing torque	40.1 kNm
Maximum flow	80 l/min
Maximum pressure	370 bar

Tires

- | | |
|-----------------------------------|--|
| Standard | |
| ■ 10.00-20 (dual pneumatic) | |
| Optional | |
| ■ 11.00-20 (dual pneumatic) | |
| ■ 18 R 19.5 XF (single pneumatic) | |
| ■ 600/40-22.5 (single pneumatic) | |
| ■ 10.00-20 (dual solid rubber) | |

Hydraulic System

Tank capacity	133 liters
System	230 liters
Maximum pressure	
Implements	350 bar
Travel	350 bar
Maximum flow	220 and 80 l/min
Pilot system	
Maximum pressure	31 bar

Transmission

1st gear, forward/reverse	8 km/h
2nd gear, forward/reverse	20/25/30/34 km/h
Creeper speed (first gear)	3 km/h
Creeper speed (second gear)	13 km/h
Drawbar pull	97 kN
Maximum Gradeability	80%

Undercarriage

Maximum steering angle	32°
Oscillation axle angle	± 9°
Minimum turning radius (outside of tire)	6400 mm
Minimum turning radius (end of VA boom)	7200 mm
Minimum turning radius (end of Mono boom)	8600 mm
Ground clearance	370 mm

Service Refill Capacities

	Liter
Fuel tank capacity	235
Cooling	39
Engine crankcase	9
Rear axle housing (differential)	14
Front steering axle (differential)	10.5
Final drive	2.5
Powershift transmission	2.5

Cab

FOGS meets ISO 10262.

Sound

Low sound, low vibration. The 3054E design improves operator comfort by reducing sound and vibration. The M315C was awarded the German Blue Angel for low spectator sound levels.

Operator Sound

- The operator sound level measured according to the procedures specified in ISO 6396:1992 is L_{PA} 71 dB(A), for cab offered by Caterpillar, when properly installed and maintained and tested with the doors and windows closed.
- Hearing protection may be needed when operating with an open cab for extended periods or in a noisy environment.

Exterior Sound

- The labeled spectator sound power level measured according to the test procedures and conditions specified in 2000/14/EC is L_{WA} 101 dB(A).

Weights

Average operating weights include a general purpose bucket, 100% fuel and an operator.

VA boom	kg
rear dozer only	15 500
rear dozer, front outriggers	16 400
front and rear outriggers	16 650
One-piece boom	
rear dozer only	15 000
rear dozer, front outriggers	15 900
front and rear outriggers	16 150
Dozer blade	645
Outriggers	890
Counterweights	
Standard	3500
Optional	3900

Dimensions

All dimensions are approximate – measured in mm

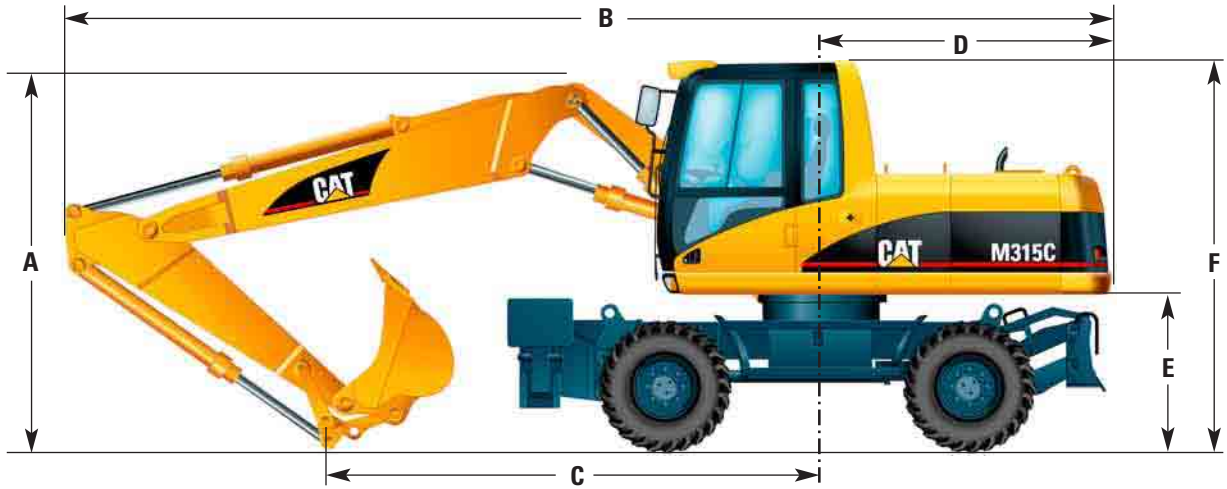

	VA boom mm	One-piece boom mm
A Shipping height (cab height)	3150	3150
B Shipping length		
2100 mm stick	8480	8320
2400 mm stick	8480	8330
2600 mm stick	8470	8330
C Support Point		
2100 mm stick	3910	3560
2400 mm stick	3660	3280
2600 mm stick	3560	3160
D Tail swing radius	2197	2197
E Counterweight clearance	1262	1262
F Cab height	3150	3150
with 1200 mm fixed cab riser	4350	4350
Overall machine width		
Standard gauge axle	2550	2550
Wide gauge axle	2750	2750

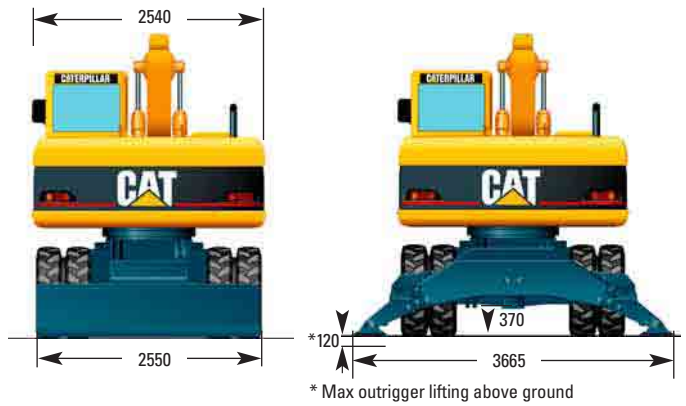

* Max outrigger lifting above ground

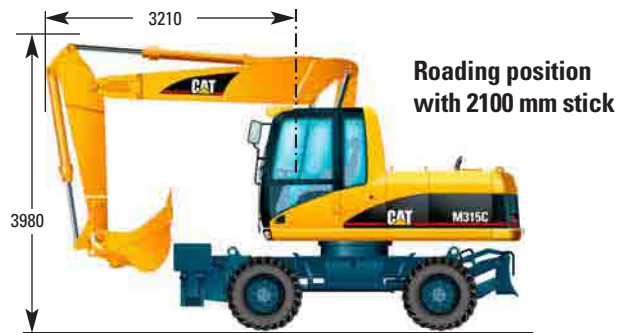

Undercarriage with dozer only

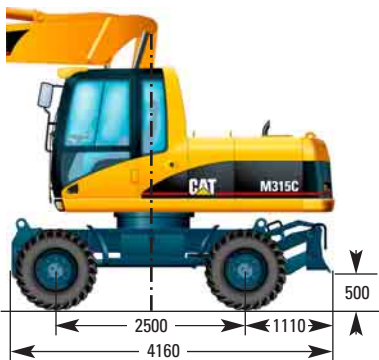

Undercarriage with 2 sets of outriggers

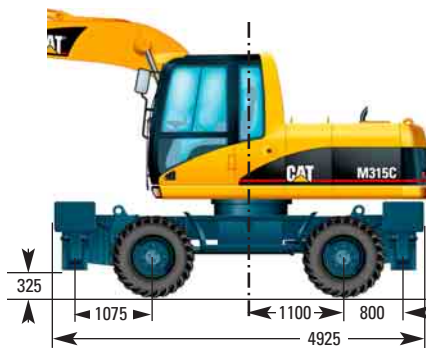

Undercarriage with 1 set of outriggers and dozer

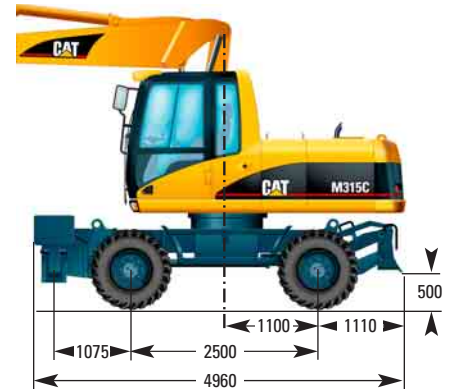

Bucket Specifications

Contact your Caterpillar dealer for special bucket requirements.
Buckets are available to fit the Cat quick coupler.

Buckets without Quick Coupler





				Variable adjustable boom 5200 mm												One-piece boom 5050 mm												
Stick length				2100 mm				2400 mm				2600 mm				2100 mm				2400 mm				2600 mm				
	Width	Weight*	Capacity (ISO)	Free on Wheels	Dozer lowered	1 set of stabilizer lowered	Fully stabilized	Free on Wheels	Dozer lowered	1 set of stabilizer lowered	Fully stabilized	Free on Wheels	Dozer lowered	1 set of stabilizer lowered	Fully stabilized	Free on Wheels	Dozer lowered	1 set of stabilizer lowered	Fully stabilized	Free on Wheels	Dozer lowered	1 set of stabilizer lowered	Fully stabilized	Free on Wheels	Dozer lowered	1 set of stabilizer lowered	Fully stabilized	
																												mm
Excavation	600	459	0.38																									
	750	495	0.52																									
	900	557	0.65																									
	1000	591	0.75																									
	1100	622	0.84																									
	1200	668	0.94																									
	1300	699	1.03																									
	1400	731	1.13																									
Extreme Excavation	1200	702	0.94																									
	1300	735	1.03																									

Buckets and Quick Coupler

				Variable adjustable boom 5200 mm												One-piece boom 5050 mm												
Stick length				2100 mm				2400 mm				2600 mm				2100 mm				2400 mm				2600 mm				
	Width	Weight**	Capacity (ISO)	Free on Wheels	Dozer lowered	1 set of stabilizer lowered	Fully stabilized	Free on Wheels	Dozer lowered	1 set of stabilizer lowered	Fully stabilized	Free on Wheels	Dozer lowered	1 set of stabilizer lowered	Fully stabilized	Free on Wheels	Dozer lowered	1 set of stabilizer lowered	Fully stabilized	Free on Wheels	Dozer lowered	1 set of stabilizer lowered	Fully stabilized	Free on Wheels	Dozer lowered	1 set of stabilizer lowered	Fully stabilized	
																												mm
Excavation	600	688	0.38																									
	750	724	0.52																									
	900	754	0.65																									
	1000	788	0.75																									
	1100	820	0.84																									
	1200	865	0.94																									
	1300	896	1.03																									
	1400	928	1.13																									
Extreme Excavation	1200	899	0.94																									
	1300	932	1.03																									

* Bucket weight includes general duty tips.

** Bucket weight includes CW20 quick coupler and general duty tips.

	Maximum Material density 1800 kg/m ³
	Maximum Material density 1500 kg/m ³
	Maximum Material density 1200 kg/m ³
	Not Recommended

Work Tools Matching Guide

















When choosing between various work tool models that can be installed onto the same machine configuration, consider work tool application, productivity requirements, and durability. Refer to work tool specifications for application recommendations and productivity information.

Without quick coupler		Variable adjustable boom 5200 mm									One-piece boom 5050 mm								
		Dozer lowered			2 sets of stabilizer lowered			Dozer and stabilizer lowered			Dozer lowered			2 sets of stabilizer lowered			Dozer and stabilizer lowered		
		2100	2400	2600	2100	2400	2600	2100	2400	2600	2100	2400	2600	2100	2400	2600	2100	2400	2600
Hammers	H100, H115 s																		
	H120C s	x	x	x	x	x	x	x	x	x		x	x		x	x		x	x
Multiprocessors	MP15	CC, CR, PS, S	x	x	x							x	x	x					
		PP	x	x	x			x			x	x	x			x			x
Crushers and Pulverizers	VHC-30		x	x	x							x	x	x					
	VHP-30		x	x	x							x	x	x					
360° rotatable Shears (boom mounted)	S320																		
	S325		x	x	x							x	x	x					
Multi-Grapples	G310B	D																	
		R																	
	G315B	D, R	x	x	x							x	x	x					
Compactors	CVP75																		
Digging Clamshell Buckets	GG5-25																		
	GG5-35		x	x	x							x	x	x					
Transfer Clamshell Buckets	GOS-25	460																	
		520/580			x														
		750/900	x	x	x							x	x	x					
		980/1140	x	x	x							x	x	x					
	GOS-35	620	x	x	x							x	x	x					
		700/780	x	x	x							x	x	x					
		1050	x	x	x							x	x	x					
		1260	x	x	x			x			x	x	x			x			x
	1460/1670	x	x	x	x	x	x	x	x	x	x	x	x		x	x		x	
Orange Peel Grapples	GSM-25 5 tines	400	x	x	x								x	x					
		500/600/800	x	x	x								x	x	x				
	GSM-35 5 tines	500	x	x	x							x	x	x					
		600	x	x	x							x	x	x					
		800	x	x	x							x	x	x					
	GSH15B 5 tines	400/500/600	x	x	x							x	x	x					
		800	x	x	x							x	x	x					
	GSH15B 4 tines	400	x	x	x							x	x	x					
500/600		x	x	x							x	x	x						
	800	x	x	x							x	x	x						
With quick coupler																			
Quick Couplers	CW-20, 20S																		
Multiprocessors	MP15	CC, CR, S	x	x	x	x	x	x	x	x	x	x	x			x			x
		PP, PS	x	x	x	x	x	x	x	x	x	x	x			x	x		x
Crushers and Pulverizers	VHC-30		x	x	x	x	x	x	x	x	x	x	x			x			x
	VHP-30		x	x	x	x	x	x	x	x	x	x	x						
Multi-Grapples	G310B	D	x	x	x														
		R	x	x	x														
	G315B	D	x	x	x														
		R	x	x	x			x			x	x	x			x			x
Compactors	CVP75																		

















- 360° Working Range
- Over the front only
- Available
- Maximum Material density 3000 kg/m³
- Maximum Material density 1800 kg/m³
- Maximum Material density 1200 kg/m³
- x Not Compatible

Lift capacities

















with 5200 mm Variable adjustable boom, Quick Coupler CW and 3900 kg counterweight. All weights are in kg.

Stick 2100 mm		Undercarriage configuration	3.0 m			4.5 m			6.0 m			7.5 m						m
																		
6.0 m	Rear dozer up				*4900		4300	4100		2600								
	Rear dozer down				*4900		4800		*4400		3000							
	Rear stab down				*4900		*4900		*4400		3600							
	2 sets stab down Dozer and stab down				*4900		*4900		*4400		*4400							
4.5 m	Rear dozer up	*6200		*6200	*5600		4200	4100		2700								
	Rear dozer down		*6200	*6200	*5600		4700		*4600		3100							
	Rear stab down		*6200	*6200	*5600		*5600		*4600		3600							
	2 sets stab down Dozer and stab down	*6200		*6200	*5600		*5600		*4600		*4600							
3.0 m	Rear dozer up	*7400		7300	6100		4100	4000		2700	2700		1700	*2400		1500	8.11	
	Rear dozer down		*7400	*7400		*6500	*4600		*4900		3000		1900		*2400	1700		
	Rear stab down		*7400	*7400		*6500	5400		*4900		*3600		2400		*2400	2100		
	2 sets stab down Dozer and stab down	*7400		*7400	*6500		*6500	*4900		*4900	*4000	3500	2500	*2400		*2400	2400	
1.5 m	Rear dozer up	*9200		*7000	*6000		4000	4100		2600	2700		1600	2300		1400	8.21	
	Rear dozer down		*9200	8200		*7200	4500		*5200		3000		1900		*2500	1700		
	Rear stab down		*9200	*9200		*7200	5400		*5200		3500		2300		*2500	2000		
	2 sets stab down Dozer and stab down	*9200		*9200	*7200		*7200	*5200		*4300	*4000	3500	2500	*2500		*2500	2500	
0 m	Rear dozer up	*10900		6900	6100		3900	3900		2400	2600		1600	2400		1500	7.99	
	Rear dozer down		*10900	8200		*7200	4500		*5200		2800		1800		*2600	1700		
	Rear stab down		*10900	10000		*7200	5400		*5200		3400		2300		*2600	2100		
	2 sets stab down Dozer and stab down	*10900		*10900	*7200		*7200	*5200		5000	*3700	3400	2600	*2600		*2600	2600	
-1.5 m	Rear dozer up	11800		6700	6100		3700	3800		2300				2700		1600	7.42	
	Rear dozer down		*11900	8000		*7400	4300		*5200		2700				*3000	1900		
	Rear stab down		*11900	10100		*7400	5300		*5200		3300				*3000	2300		
	2 sets stab down Dozer and stab down	*11900		*11900	*7400		*7400	*5200		4900		4900	3000	*3000		*3000	2900	
-3.0 m	Rear dozer up	*12100		6800	5900		3500											
	Rear dozer down		*12100	8000		*6900	4100											
	Rear stab down		*12100	10100		*6900	5100											
	2 sets stab down Dozer and stab down	*12100		*12100	*6900		*6900											

Stick 2400 mm

Stick 2400 mm		Undercarriage configuration	3.0 m			4.5 m			6.0 m			7.5 m						m
																		
6.0 m	Rear dozer up				*4400		4300	4100		2700								
	Rear dozer down				*4400		*4400		*4200		3000							
	Rear stab down				*4400		*4400		*4200		3600							
	2 sets stab down Dozer and stab down				*4400		*4400		*4200		*4200							
4.5 m	Rear dozer up	*4600		*4600	*5100		4200	4100		2700	*2700		1700					
	Rear dozer down		*4600	*4600	*5100		4700		*4400		3100		2000					
	Rear stab down		*4600	*4600	*5100		*5100		*4400		3600		2400					
	2 sets stab down Dozer and stab down	*4600		*4600	*5100		*5100	*4400		*4400	*2700	4400	2700	*2700				
3.0 m	Rear dozer up	*7900		*7200	6100		4100	4000		2700	2800		1700	*2100		1400	8.38	
	Rear dozer down		*7900	*7900		*6300	4600		*4800		3100		2000		*2100	1600		
	Rear stab down		*7900	*7900		*6300	5400		*4800		*3600		2400		*2100	2000		
	2 sets stab down Dozer and stab down	*7900		*7900	*6300		*6300	*4800		*4800	*3900	4300	3000	*2100		*2100	2100	
1.5 m	Rear dozer up	*9100		7000	6000		3900	4000		2600	2700		1700	*2200		1300	8.48	
	Rear dozer down		*9100	8100		*7100	4500		*5100		3000		1900		*2200	1600		
	Rear stab down		*9100	*9100		*7100	5300		*5100		3600		2400		*2200	1900		
	2 sets stab down Dozer and stab down	*9100		*9100	*7100		*7100	*5100		4900	*4000	4300	3500	*2200		*2200	2200	
0 m	Rear dozer up	*10600		7000	6100		3900	3900		2500	2600		1600	2300		1400	8.27	
	Rear dozer down		*10600	8300		*7200	4500		*5200		2900		1900		*2300	1600		
	Rear stab down		*10600	10000		*7200	5400		*5200		3400		2300		*2300	2000		
	2 sets stab down Dozer and stab down	*10600		*10600	*7200		*7200	*5200		5000	*3900	4200	2800	*2300		*2300	2300	
-1.5 m	Rear dozer up	11700		6700	6100		3700	3800		2300				2500		1500	7.73	
	Rear dozer down		*11700	8000		*7300	4300		*5300		2700				*2700	1800		
	Rear stab down		*11700	10100		*7300	5200		*5300		3300				*2700	2200		
	2 sets stab down Dozer and stab down	*11700		*11700	*7300		*7300	*5300		4900		4100	3000	*2700		*2700	2700	
-3.0 m	Rear dozer up	12100		6700	5900		3500	3700		2200								
	Rear dozer down		*12100	8000		*7200	4100		*3800		2600							
	Rear stab down		*12100	10100		*7200	5000		*3800		3200							
	2 sets stab down Dozer and stab down	*12100		*12100	*7200		*7200	*3800		6400	*3800							

Stick
2600 mm

		Undercarriage configuration	3.0 m			4.5 m			6.0 m			7.5 m						m		
																				
6.0 m		Rear dozer up Rear dozer down Rear stab down 2 sets stab down Dozer and stab down				*4000			*4000	*4000	*4100									
							*4000		*4000	*4100	*4100									
						*4000			*4000	*4100										
						*4000			*4000	*4100										
4.5 m		Rear dozer up Rear dozer down Rear stab down 2 sets stab down Dozer and stab down				*4600			4200	4100										
							*4600		*4600	*4300	*4300									
						*4600			*4600	*4300										
						*4600			*4600	*4300										
3.0 m		Rear dozer up Rear dozer down Rear stab down 2 sets stab down Dozer and stab down	*7400		7300	*6100			4100	4000										
				*7400	*7400	*6100			4600	*4700	*4700									
				*7400	*7400	*6100			5400	*4700										
				*7400	*7400	*6100			*6100	*4700										
				*7400	*7400	*6100			*6100	*4700										
1.5 m		Rear dozer up Rear dozer down Rear stab down 2 sets stab down Dozer and stab down	*9200		7100	6000			4000	4000										
				*9200	8100	*7000			4500	*5100	*5100									
				*9200	9200	*7000			5300	*5100										
				*9200	*9200	*7000			*7000	*5100										
				*9200	*9200	*7000			6400	*5100										
0 m		Rear dozer up Rear dozer down Rear stab down 2 sets stab down Dozer and stab down	*10300		7000	6000			3900	4000										
				*10300	8200	*7200			4500	*5200	*5200									
				*10300	9900	*7200			5300	*5200										
				*10300	*10300	*7200			*7200	*5200										
				*10300	*10300	*7200			6400	*5200										
-1.5 m		Rear dozer up Rear dozer down Rear stab down 2 sets stab down Dozer and stab down	*11600		6700	6100			3700	3800										
				*11700	8000	*7300			4300	*5300	*5300									
				*11700	10100	*7300			5300	*5300										
				*11700	*11700	*7300			*7300	*5300										
				*11700	*11700	*7300			6600	*5300										
-3.0 m		Rear dozer up Rear dozer down Rear stab down 2 sets stab down Dozer and stab down	12100		6700	5900			3500	3700										
				*12100	7900	*7400			4100	*4300	*4300									
				*12100	10000	*7400			5100	*4300										
				*12100	*12100	*7400			*7400	*4300										
				*12100	*12100	*7400			6400	*4300										
-4.5 m		Rear dozer up Rear dozer down Rear stab down 2 sets stab down Dozer and stab down	*8400		6600															
				*8400	7800															
				*8400	*8400															
				*8400	*8400															
				*8400	*8400															

















For machines with offset boom deduct approx. 3% from the above loads.



















* Limited by hydraulic rather than tipping load.
The above loads are in compliance with hydraulic excavator lift capacity ratings standard ISO 10567, they do not exceed 87% of hydraulic lifting capacity or 75% of tipping capacity. Weight of all tools and lifting accessories must be deducted from the above lifting capacities.

















Lift capacities

with 5050 mm One-piece boom, Quick Coupler CW and 3900 kg counterweight. All weights are in kg.

Stick 2100 mm		Undercarriage configuration	3.0 m			4.5 m			6.0 m			7.5 m						m
																		
6.0 m	Rear dozer up							4000		2600								
	Rear dozer down								*4100	3000								
	Rear stab down								*4100	3500								
	2 sets stab down							*4100		*4100								
	Dozer and stab down							*4100		*4100								
4.5 m	Rear dozer up				*5300			4100		2600								
	Rear dozer down					*5300		4600		2900								
	Rear stab down					*5300		5300		3500								
	2 sets stab down				*5300			*4500		*4500								
	Dozer and stab down				*5300			*4500		4300								
3.0 m	Rear dozer up				6100			3800		3900					*2400		1600	7.90
	Rear dozer down					*6300		4300		2800					*2400	1900		
	Rear stab down					*6300		5300		3400					*2400	2200		
	2 sets stab down				*6300			*6300	*4900	*4900					*2400	*2400		
	Dozer and stab down				*6300			*6300	*4900	4200					*2400	*2400		
1.5 m	Rear dozer up				5800			3500		3800					2500		1500	8.01
	Rear dozer down					*7200		4100		2700					*2500	1800		
	Rear stab down					*7200		5000		3300					*2500	2100		
	2 sets stab down				*7200			*7200	*5200	4900	*3700				*2500	*2500		
	Dozer and stab down				*7200			6200	*5200	4100	*3700				*2500	*2500		
0 m	Rear dozer up				5600			3300		3700					2500		1600	7.79
	Rear dozer down					*7300		3900		2600					*2700	1800		
	Rear stab down					*7300		4800		3200					*2700	2200		
	2 sets stab down				*7300			*7300	*5300	4800					*2700	*2700		
	Dozer and stab down				*7300			6100	*5300	4000					*2700	*2700		
-1.5 m	Rear dozer up	*7400			6100			3300		3600					2800		1800	7.21
	Rear dozer down		*7400		7300			3900		2600					*3100	2000		
	Rear stab down		*7400		*7400			4800		3200					*3100	2500		
	2 sets stab down	*7400			*6700			*6700	*4800	4800					*3100	*3100		
	Dozer and stab down	*7400			*6700			6000	*4800	3900					*3100	3100		
-3.0 m	Rear dozer up	*6900			6200			3400							*3000		2200	6.15
	Rear dozer down		*6900		*6900			3900		2600					*3000	2600		
	Rear stab down		*6900		*6900			4900		3200					*3000	*3000		
	2 sets stab down	*6900			*5200			*5200		4800					*3000	*3000		
	Dozer and stab down	*6900			*5200			6100	*5200	4000					*3000	*3000		

Stick 2400 mm		Undercarriage configuration	3.0 m			4.5 m			6.0 m			7.5 m						m
																		
6.0 m	Rear dozer up									4000								
	Rear dozer down									*4000								
	Rear stab down									*4000								
	2 sets stab down									*4000								
	Dozer and stab down									*4000								
4.5 m	Rear dozer up									4000								
	Rear dozer down									*4300								
	Rear stab down									*4300								
	2 sets stab down									*4300								
	Dozer and stab down									*4300								
3.0 m	Rear dozer up				*6100			3800		3900					2500	2700	1700	8.16
	Rear dozer down					*6100		4400		2800					*3700	2000		
	Rear stab down					*6100		5300		3400					*3700	2400		
	2 sets stab down				*6100			*6100	*4700	*4700					*2100	3500		
	Dozer and stab down				*6100			*6100	*4700	4200	*3700				*2100	3000		
1.5 m	Rear dozer up				5800			3500		3800					2300	2700	1600	8.27
	Rear dozer down					*7000		4100		2700					*4100	1900		
	Rear stab down					*7000		5000		3300					3800	2300		
	2 sets stab down				*7000			*7000	*5100	4900	*4100				*2200	3500		
	Dozer and stab down				*7000			6300	*5100	4100	*4100				*2200	2900		
0 m	Rear dozer up	*3700			5600			3300		3600					2600	2600	1600	8.05
	Rear dozer down		*3700		*7300			3900		2600					*3900	1900		
	Rear stab down		*3700		*7300			4800		3200					3800	2300		
	2 sets stab down	*3700			*7300			*7300	*5300	*5300					*2400	3400		
	Dozer and stab down	*3700			*7300			6100	*5300	3900	*3900				*2400	2900		
-1.5 m	Rear dozer up	*7200			6000			3300		3600					2700		1600	7.50
	Rear dozer down		*7200		7200			3800		2600							1900	
	Rear stab down		*7200		*7200			4700		3100							2300	
	2 sets stab down	*7200			*6800			*6800	*4900	4700					*2800	3700		
	Dozer and stab down	*7200			*6800			6000	*4900	3900					*2800	2900		
-3.0 m	Rear dozer up	*7600			6100			3300		*3600					*3100		2000	6.49
	Rear dozer down		*7600		7300			3900		2600					*3100	2400		
	Rear stab down		*7600		*7600			4800		3200					*3100	2900		
	2 sets stab down	*7600			*5500			*5500	*3600	*3600					*3100	*3100		
	Dozer and stab down	*7600			*5500			6100	*3600	3600					*3100	*3100		

Stick
2600 mm

		Undercarriage configuration	3.0 m			4.5 m			6.0 m			7.5 m						m		
																				
6.0 m		Rear dozer up Rear dozer down Rear stab down 2 sets stab down Dozer and stab down							*3900		2700									
									*3900	*3900	3000									
									*3900	*3900	3600									
									*3900		*3900									
									*3900		*3900									
4.5 m		Rear dozer up Rear dozer down Rear stab down 2 sets stab down Dozer and stab down							4100		2600	*2300		1700						
									*4200	*4200	3000		*2300	2000						
									*4200	*4200	3600		*2300	*2300	*2300					
									*4200		*4200	*2300		*2300	*2300					
									*4200		*4200	*2300		*2300	*2300					
3.0 m		Rear dozer up Rear dozer down Rear stab down 2 sets stab down Dozer and stab down				*5900		3800	3900		2500	2700		1700	*1900		1400		8.36	
						*5900		4400		*4600	2900		2000	*1900		1700				
						*5900	*5900	5400		*4600	3400		2400	*1900		1700				
						*5900		5900	*4600		*4600	*3900	3500	*1900		1900				
						*5900		6300	*4600		4200	*3900	3000	*1900		1900				
1.5 m		Rear dozer up Rear dozer down Rear stab down 2 sets stab down Dozer and stab down				5800		3500	3800		2300	2700		1700	*2000		1400		8.46	
						*6900		4100		*5100	2700		1900	*2000		1600				
						*6900		5000		*5100	3300		2300	*2000		2000				
						*6900		6300	*5100		4900	*4100	3500	*2000		2000				
						*6900		6300	*5100		4100	*4100	2900	*2000		2000				
0 m		Rear dozer up Rear dozer down Rear stab down 2 sets stab down Dozer and stab down	*3900		*3900	5600		3300	3700		2200	2600		1600	*2200		1400		8.25	
				*3900	*3900		*7300	3900		*5300	2600		1900	*2200		1600				
				*3900	*3900		*7300	4800		*5300	3200		2300	*2200		2000				
				*3900	*3900	*7300		7300	*5300		4800	*4000	3400	*2200		2200				
				*3900	*3900	*7300		6100	*5300		4000	*4000	2800	*2200		2200				
-1.5 m		Rear dozer up Rear dozer down Rear stab down 2 sets stab down Dozer and stab down	*7000		6000	5500		3300	3600		2200			2500		1600		7.71		
				*7000	*7000		*7000	3800		*5000	2500			*2600		1800				
				*7000	*7000		*7000	4700		*5000	3100			*2600		2200				
				*7000	*7000	*7000		7000	*5000		4700			*2600		2600				
				*7000	*7000	*7000		6000	*5000		3900			*2600		2600				
-3.0 m		Rear dozer up Rear dozer down Rear stab down 2 sets stab down Dozer and stab down	*8100		6100	5600		3300	3600		2200			*3100		1900		6.74		
				*8100	7300		*5800	3900		*3900	2600			*3100		2200				
				*8100	8100		*5800	4800		*3900	3200			*3100		2700				
				*8100	8100	*5800		5800	*3900		3900			*3100		3100				
				*8100	8100	*5800		5800	*3900		3900			*3100		3100				



* Limited by hydraulic rather than tipping load.
The above loads are in compliance with hydraulic excavator lift capacity ratings standard ISO 10567, they do not exceed 87% of hydraulic lifting capacity or 75% of tipping capacity. Weight of all tools and lifting accessories must be deducted from the above lifting capacities.

VA Boom Working Ranges

5200 mm Variable adjustable boom, quick coupler and bucket.

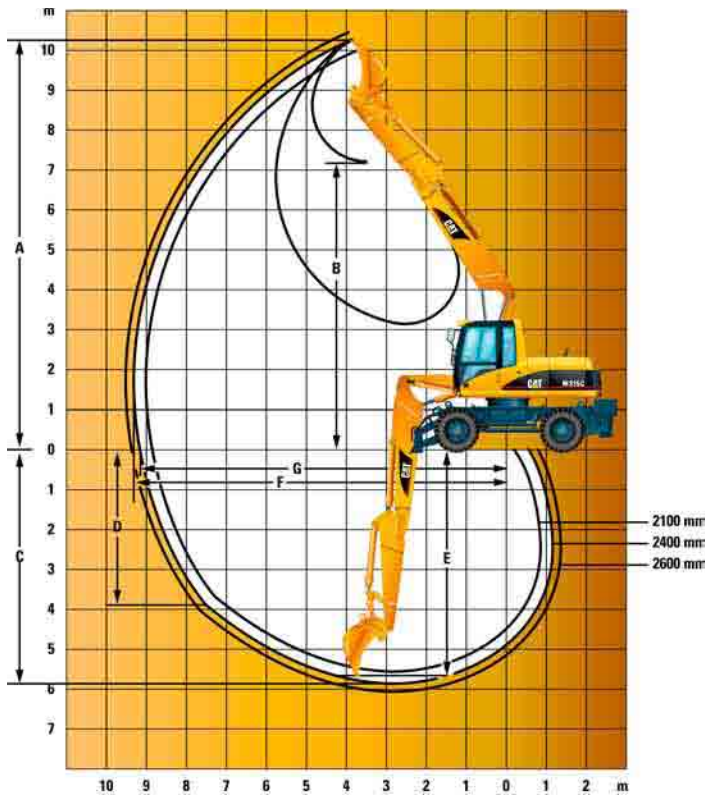

Stick Length	mm	2100	2400	2600
A Maximum Digging Height	mm	10 040	10 230	10 380
B Maximum Dump Height	mm	6950	7140	7300
C Maximum Digging Depth	mm	5590	5890	6090
D Maximum Vertical Wall Digging Depth	mm	3720	3920	4090
E Maximum Depth 2500 mm Straight Clean-up	mm	5369	5687	5897
F Maximum Reach	mm	9100	9360	9560
G Maximum Reach at Ground Level	mm	8910	9190	9380
Tip Radius	mm	1552	1552	1552
Bucket Forces (ISO 6015)	kN	93	93	93
Stick Forces (ISO 6015)	kN	75	69	66

One-piece Boom Working Ranges

5050 mm One-piece boom, quick coupler and bucket.

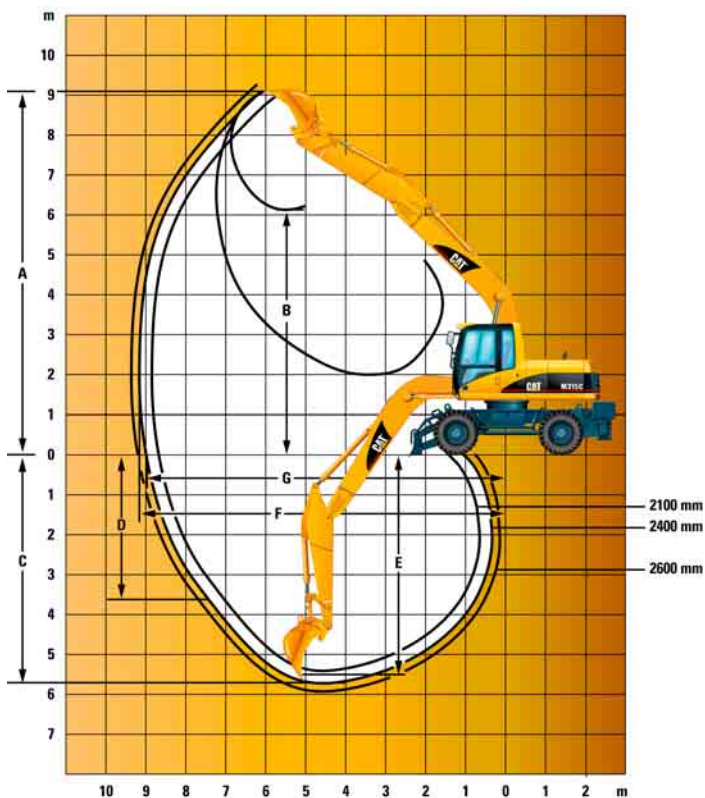

Stick Length	mm	2100	2400	2600
A Maximum Digging Height	mm	8980	9070	9190
B Maximum Dump Height	mm	6000	6110	6230
C Maximum Digging Depth	mm	5390	5690	5890
D Maximum Vertical Wall Digging Depth	mm	3510	3650	3820
E Maximum Depth 2500 mm Straight Clean-up	mm	5169	5487	5697
F Maximum Reach	mm	8900	9160	9350
G Maximum Reach at Ground Level	mm	8710	8970	9170
Tip Radius	mm	1552	1552	1552
Bucket Forces (ISO 6015)	kN	93	93	93
Stick Forces (ISO 6015)	kN	75	69	66

Standard Equipment

Standard equipment may vary. Consult your Caterpillar dealer for specifics.

Operator Station

Ashtray with cigarette lighter
Air conditioner with automatic climate control
Bolt-on FOGS capability
Bottom mounted parallel wiper and washer
Coat hook
Drink holder
Filtered ventilation
Floor mat, washable
Fully adjustable suspension seat
Heater and defroster
Joysticks, adjustable
LH console, tiltable
Light, interior
Literature holder
Low fuel indicator light
Openable two-piece front windscreen
Parking brake
Pre-wired radio mounting
Polycarbonate skylight
Power supply 12V – 7A
Retractable seat belt
Steering column, tiltable
Storage compartment suitable for a lunch box
Sunscreen

Language display WEX Multipro

Clock with 10-day backup battery
Filter / fluid change information
Gauges for fuel level, engine coolant temperature and hydraulic oil temperature
Headlights indicator
Indicator for engine dial setting
Pre-start level check for hydraulic oil and engine coolant
Turn signal indicator
Warning messages
Working hour information

Engine

Automatic engine speed control
Automatic starting aid
Cat 3054E DIT ATAAC Stage II engine, turbocharged with air-to-air aftercooler
Muffler

Undercarriage

10.00-20 16 PR tires
HD-axles, with advanced disc brake system and advanced travel motor with adjustable braking force
Oscillating front axle with remote greasing

Pin-on design preparation for dozer blade and outriggers
Toolbox in undercarriage
Two-piece drive shaft
Upper carriage storage box

Hydraulics

Cat XT-6 ES hoses
Load-sensing plus hydraulic system
Manual work modes (economy, power, travel)
Oil cooler
Overload warning device
Separate swing pump
Stick regeneration circuit

Electrical

Alternator, 75A
Boom working light
Heavy-duty maintenance-free batteries
Horn
Main shut-off switch
Roading lights

Other equipment

Automatic swing brake
Door locks and caps locks with Caterpillar one-key security system
Lockable Tool Box in upper frame
Mirrors, frame and cab

Optional Equipment

Optional equipment may vary. Consult your Caterpillar dealer for specifics.

Operator Station

Falling objects guard
Fixed cab riser (1200 mm)
Fixed one-piece front windscreen
Headrest
Lid for storage compartment
Travel speed lock
Vandalism guard
Visor, rain protection, polycarbonate
WEX comfort seat with seat heating and air suspension

Electrical

Back-up alarm
Refueling pump
Rotating beacon
Working lights, cab mounted (front and rear)

Booms and Sticks

Hydraulically adjustable boom (5200 mm)
Offset boom (5200 mm)
One-piece-boom (5050 mm)
Sticks:
2100 mm, 2400 mm, 2600 mm
Industrial: 3100 mm

Undercarriage

Dozer blade, front or rear mounted
Optional tires
Outriggers, front or rear mounted
Remote dozer blade greasing
Second storage box for undercarriage
Wide dozer blade, front or rear mounted
Wide gauge axles (2750 mm)

Hydraulics

Control group for quick coupler
Hammer valve
Hydraulic lines for quick coupler – boom and stick
Lowering control devices for boom and stick
Multifunction valve, provides up to 5 programmed tools and tool selection from the cab (including hammer function)
Proportional medium pressure function
Synthetic ester based biodegradable hydraulic oil

Other equipment

Adjustable hydraulic sensitivity
Cat Machine Security System (MSS)
Counterweight (3900 kg)
Custom paint
Joystick steering

M315C Wheel Excavator

HEHH2873-2 (01/2005) hr

Materials and specifications are subject to change without notice.
Featured machines in photos may include additional equipment.
See your Caterpillar dealer for available options.

www.CAT.com
© 2005 Caterpillar
All rights reserved

CATERPILLAR[®]