

Seoul Office :
 Doosan Tower 27th FL. 18-12, Euljiro-6 Ga,
 Jung-Gu, Seoul, Korea 100-730
 Tel : +82-2-3398-8114
 Fax : +82-2-3398-8117
www.doosaninfracore.com

Doosan Infracore Europe S.A.
 1A, Rue Achille Degrace, 7080 Frameries, Belgium
 Tel : +32-65-61-3230 Fax : +32-65-67-7338

Doosan Infracore U.K., Ltd.
 Doosan House, Unit 6, 3 Heol Y Gamlas, Parc Nantgarw, Nantgarw,
 Cardiff. CF15 7QU, U.K.
 Tel : +44-1443-84-2273 Fax : +44-1443-84-1933

Doosan Infracore Europe S.A. Germa
 Heinrich-von- Stephan str. 2 40764 Langenfeld, Germany
 Tel : +49-2173-2035-210 Fax : +49-2173-2035-219

Doosan Infracore France
 ZAC de La Clef Saint Pierre - Buroplus 2 1A Avenue Jean d'Alembert
 78990 Elancourt, France
 Tel : +33-(0)1-30-16-21-41 Fax : +33-(0)1-30-16-21-44

Doosan Infracore America Corporation
 2905 Shawnee Industrial Way, Suwanee, Georgia 30024, U. S. A
 Tel : +1-770-831-2200 Fax : +1-770-831-0480

Doosan Infracore China Co., Ltd.
 #28, Wuzhishan Road, Eco. & Tech, Development Zone,
 Yantai, Shandong, China
 Tel : +86-535-638-2000 Fax : +86-535-638-2004

Doosan Infracore South Africa (PTY) LTD.
 60C Electron Road, Isando 1600, Johannesburg, South Africa
 Tel : 27-11-974-2095 Fax : 27-11-974-2778

Doosan Infracore Middle East Center (Dubai)
 P.O.Box 183127, Al-Serkal Building, Air Port Road, Dubai, U.A.E
 Tel : +971-4-295-2781~2 Fax: +971-4-295-2783

Doosan Infracore Latinamerica oficina (Colombia)
 Diagonal 127A No. 17-34, oficina 302 Bogota, Colombia
 Tel : +571-216-1655 Fax: +571-648-7700

Doosan Infracore India Liaison Office
 402, A-wing, Business Square, Andheri-Kurla Road, Andheri(East),
 Mumbai - 400093
 Tel : +91-22-4030-6501 Fax: +91-22-4030-6599

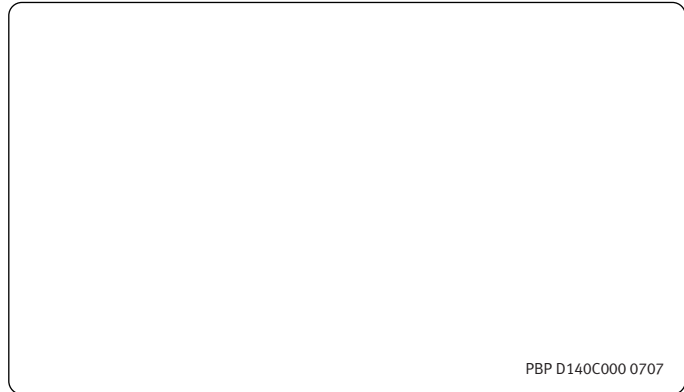

PBP D140C000 0707

The illustrations do not necessary show the product in standard version.
 All products and equipment are not available in all markets.
 Materials and specifications are subject to change without prior notice.

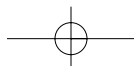



Doosan Infracore
Construction Equipment

DX140LC

Engine Power : SAE J1349, net 71 kw(95 HP)@1,850 rpm

Operational Weight : 14,000kg (30,864 lb)- STD.

Bucket capacity(SAE) : 0.24 ~ 0.76 m³ (0.31 ~ 0.99 cu.yd)





DX 140LC



The new DX140LC hydraulic excavator has all the advantages of the previous model, and now offers additional added value to the operator.

The new DX140LC was developed with the concept of "providing optimum value to the end user." In concrete terms, this translates, into :

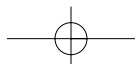



Doosan DX140LC Hydraulic Excavator : A New Model with Novel Features

Increased production and improved fuel economy is attributed to the electronic optimization of the hydraulic system and the new generation DOOSAN engine (Tier III / Stage III).

Improved ergonomics increases comfort and excellent all round visibility ensuring a safe and pleasant working environment.

Improved reliability is achieved through the use of high performance materials combined with new methods of structural stress analysis, and leads to increased component life expectancy, thus reducing running costs.

Reduced maintenance increases the availability and reduces operating costs of the excavator.

HANDLING

The hydraulic excavator's power, durability, ease of servicing and its precise control increase its effectiveness and life expectancy. With the DX140LC, DOOSAN offers an excellent return on investment.



Multi-function Color LCD Monitor Panel

Warning lights

Operation modes

- Mode selection
- Flow rate control
- Auto deceleration
- Display selection

Control panel

With color LCD display

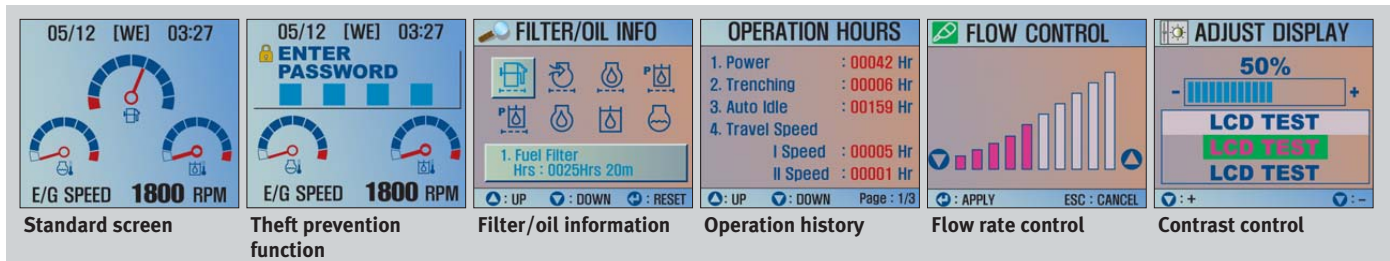

Cellular phone box



12V Power socket



Cigarette lighter



Glass antenna

Choice of operating modes

Working mode

- Digging mode: for general excavation, loading, lifting...
- Trenching mode: swing priority for trench work, canal digging, embankments...

Power mode

- Standard: uses 85% engine power for all work
- Power: uses 100% engine power for heavy work



Control lever

Very precise control of the equipment increases versatility, safety and facilitates tricky operations requiring great precision.

Leveling operations and particularly the movement of suspended loads are made easier and safer.

The control levers have additional electrical buttons for controlling other additional equipment (for example, grabs, crushers, grippers, etc.)

COMFORT

DX140LC

The work rate of the hydraulic excavator is directly linked to the performance of its operator. DOOSAN designed the DX140LC by putting the operator at the centre of the development goals. The result is significant ergonomic value that improves the efficiency and safety of the operator.

More space, better visibility, air conditioning, a very comfortable seat... These are all elements ensure that the operator can work for hours and hours in excellent conditions.



Control panel

Correct positioning with clear controls makes the operator's task easier.



The high performance air conditioning provides an air flow which is adjusted and electronically controlled for the conditions. Five operating modes enable even the most demanding operator to be satisfied.



MP3/CD Player (Optional)



Audio Button

Audio Button has been positioned in a way that the driver can turn on/off the radio, control the volume, and select a channel conveniently.

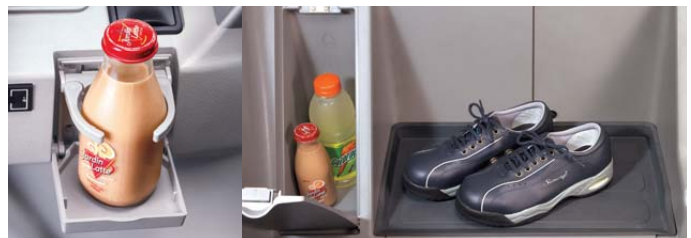

Storage space



Air suspension seat (Optional)

An Air Suspension Seat is available as an option, which further reduces any vibration being transmitted to the operator while working or travelling. In addition, this option is fitted with a heating system for operator comfort in cold weather.



Dozer Control (Optional)

The Dozer Control Lever is positional above the left-hand control stand to secure easy and convenient access.



Comfortable 2-stage sliding seat



Control stand (Telescopic Function)

PERFORMANCE

The performance of the DX140LC has a direct effect on its productivity. Its new "Common Rail" engine and new e-EPOS controlled hydraulic system have combined to create an unbeatable hydraulic excavator, with a cost/performance ratio that makes the DX140LC even more appealing.

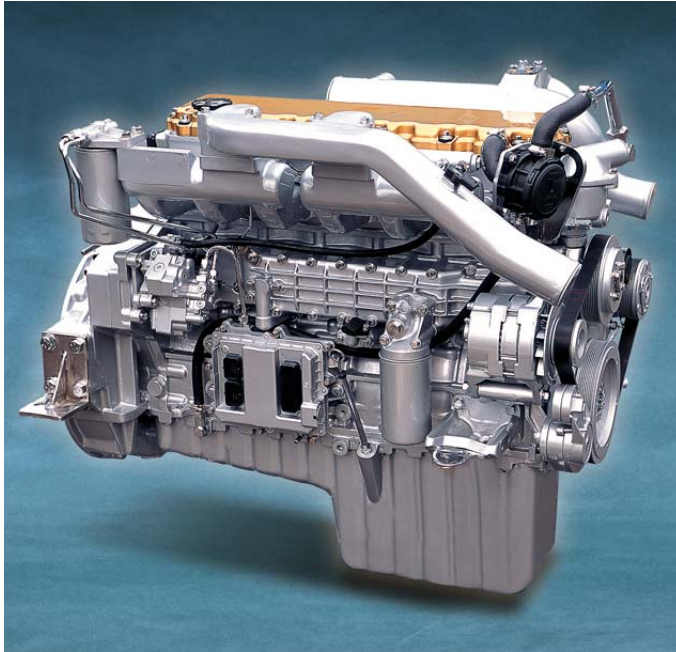

"COMMON RAIL" DOOSAN DL06 ENGINE

At the heart of the hydraulic excavator is the new "Common Rail" DOOSAN DL06 engine. It is combined with the new e-EPOS electronic control system, for optimum power and fuel saving.

The new engine produces 95 hp (71 kw/96 PS) at only 1,850 rpm, and more torque, due to its careful design combined with the use of common rail injection and 4 valves per cylinder. These features help optimize combustion and minimize pollution through reduced Nox & particulate emissions.

Increased torque allows efficient use of the power of the hydraulic system.

- Faster working cycles increase productivity.
- Increased torque means the excavator is able to move more easily.
- Energy efficiency reduces fuel consumption.

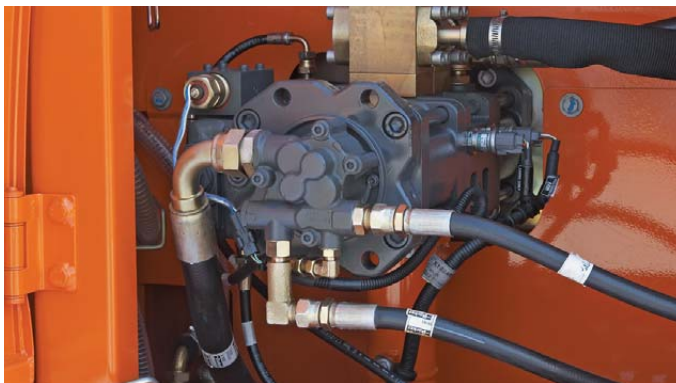

Hydraulic Pump

The Main pump has a capacity of 2x114 ℓ /min(@ 1,850 rpm) reducing cycle time while a high capacity gear pump improves pilot line efficiency.



Swing Drive

Shocks during rotation are minimized, while increased torque is available to ensure rapid cycles.

DOOSAN is aware of the importance of protecting the environment. Ecology was uppermost in the minds of the research workers right from the start of the design of the new machines. The new challenge for the engineers is to combine the protection of nature with equipment performance and to this end DOOSAN has been investing heavily.

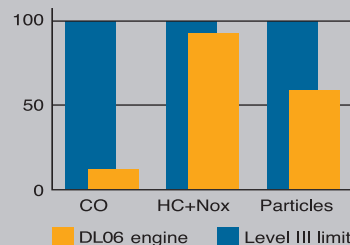

The new DOOSAN engine respects and protects the environment, limiting all types of toxic emissions.

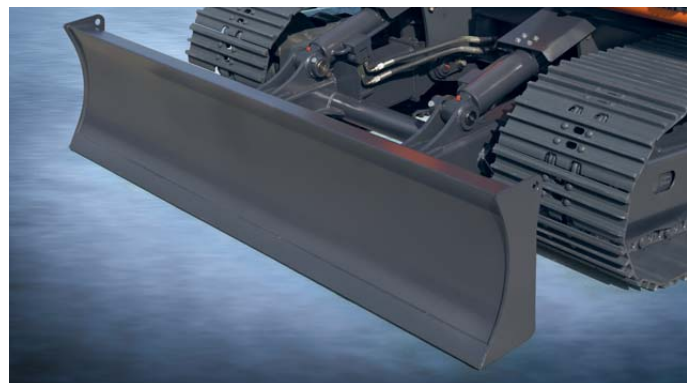

Dozer Blade (Optional)

The pin type design allows the dozer blade to be mounted on the front and/or rear and is used for leveling, clean-up work and for stabilizing the machine during digging applications. The large dozer bottom and parallel design provide minimized ground pressure.

DX140LC

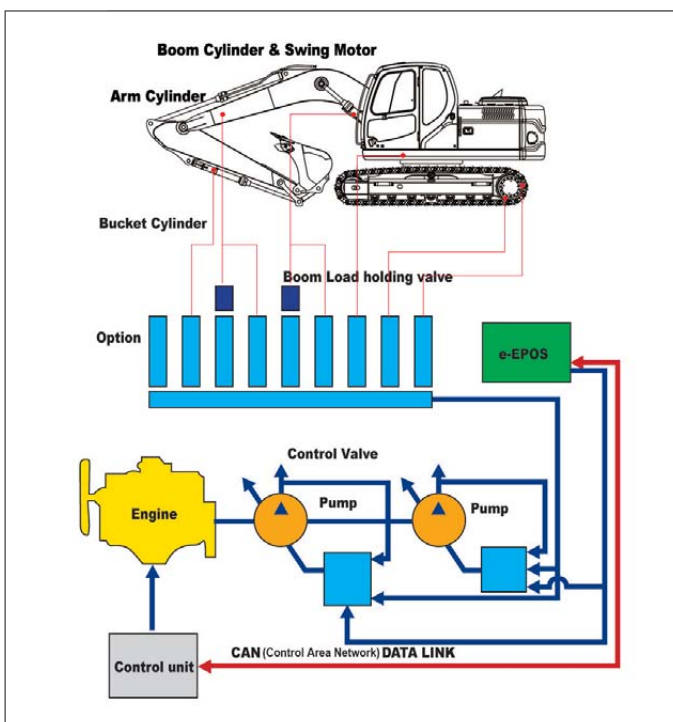

EXCAVATOR CONTROL

New e-EPOS system (Electronic Power Optimizing System)

The brains of the hydraulic excavator, the e-EPOS, have been improved and now can electronically link to the engine's ECU (Electronic Control Unit), through a CAN (Controller Area Network) communication link, enabling a continuous exchange of information between the engine and the hydraulic system. These units are now perfectly synchronised.

The advantages of the new e-EPOS impacts at several levels, Ease of operation and user-friendliness:

- The availability of a power mode and a normal operating mode guarantee maximum efficiency under all conditions.
- Electronic control of fuel consumption optimizes efficiency.
- The automatic deceleration mode enables fuel saving.
- Regulation and precise control of the flow rate required by the equipment are available as standard.
- A self-diagnosis function enables technical problems to be resolved quickly and efficiently.
- An operational memory provides a graphic display of the status of the machine.
- Maintenance and oil change intervals can be displayed.

RELIABILITY

The reliability of a product contributes to its overall lifetime operating costs. Doosan uses computer-assisted design techniques, highly durable materials and a quality engineered structure. Our research and development engineers test all product under the most extreme conditions. Durability, reliability and product longevity are Doosan's top priorities."

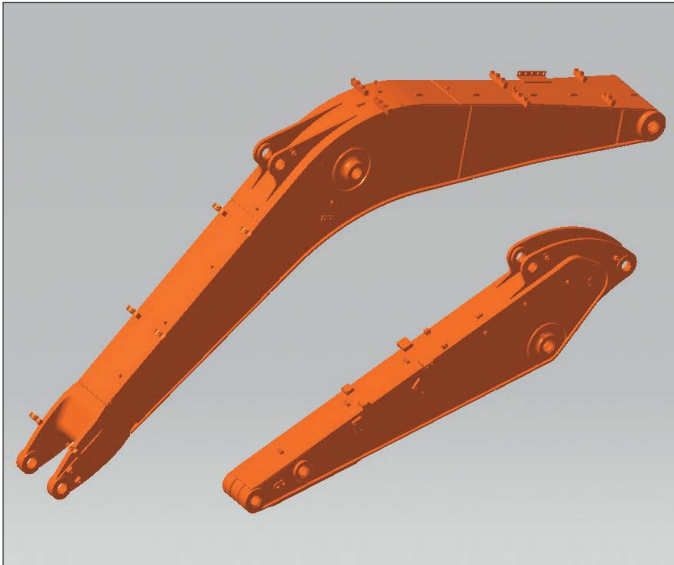

Strengthened Boom

The shape of the boom has been optimized by finite elements design, allowing uniform load distribution throughout the structure. This combined with increased material thickness means improved durability and reliability by limiting element fatigue.

Arm Assembly

In the arm assembly greater strength has been gained by using cast elements and reinforcement around the bosses to give increased life.

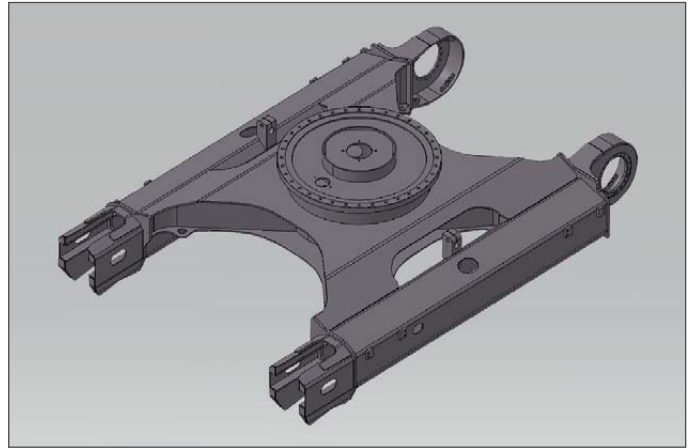

X-chassis

The X-chassis frame section has been designed using finite element and 3-dimensional computer simulation, to ensure greater durability and optimum structural integrity. The swing gear is solid and stable.

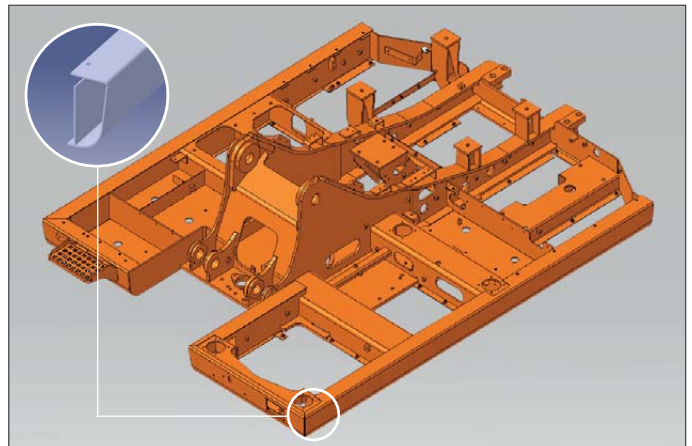

D-type Frame

The D-type frame design adds strength and minimizes distortion due to shocks.



Bushing

A highly lubricated metal is used for the boom pivot in order to increase the lifetime and extend the greasing intervals to 250 hours. A rolled bushing with very fine grooves has been added to the arm, bucket pivot; so greasing is only required every 50 hours.



Ultra-hard wear-resistant disc

New materials have been used in order to increase the wear resistance and to increase the service intervals. The longevity is greatly increased by the addition of wear plates on the inside and outside of the bucket lugs.

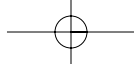

DX140LC



Integrated Track Spring and Idler

The track spring and the idler have been joined directly to achieve high durability and improved maintenance convenience.

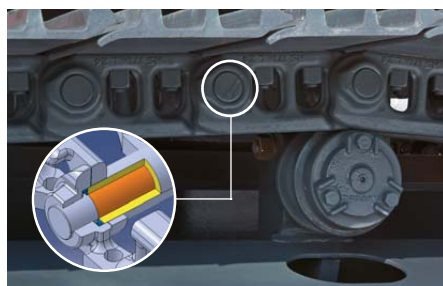

Tracks

The chain is composed of self-lubricating sealed links isolated from all external contamination. The tracks are locked by mechanically bolted pins.



Polymer shim

A polymer shim is added to the bucket pivot to promote extended pin and bushing life.

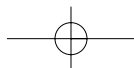

MAINTENANCE

Short maintenance operations at long intervals increase the availability of the equipment on site. DOOSAN has developed the DX140LC with a view to high profitability for the user.

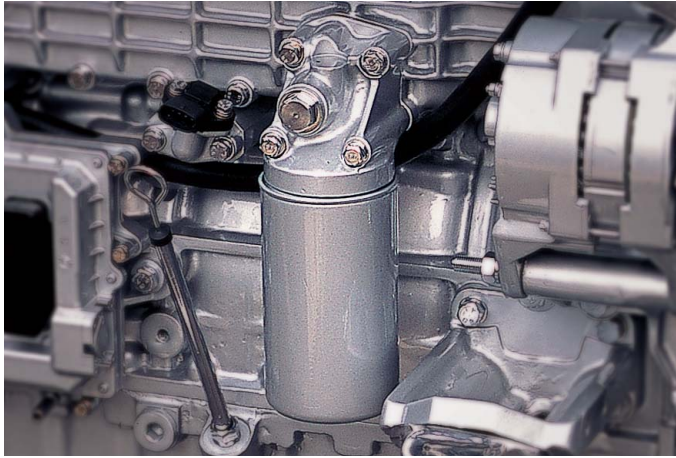

Engine oil filter

The engine oil filter offers a high level of filtration allowing the oil change interval to be increased to 500 hours. It is easy to access and is positioned to avoid contaminating the surrounding environment.



Easy maintenance

Access to the various radiators and coolers is very easy, making cleaning easier. Access to the various parts of the engine is from the top and via side panels.



Hydraulic oil return filter

The protection of the hydraulic system is more effective, using glass fiber filter technology in the main oil return filter. This means that with more than 99.5% of foreign particles filtered out, the oil change interval is increased.



Air cleaner

The large capacity forced air cleaner removes over 99% of airborne particles, reducing the risk of engine contamination and making the cleaning and cartridge change intervals greater.



Fuel pre-filter

High efficiency fuel filtration is attained by the use of multiple filters, including a fuel pre-filter fitted with a water separator that removes most moisture from the fuel.

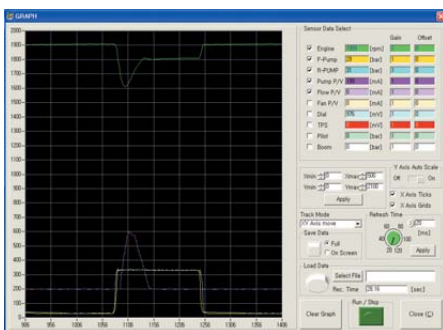

PC Monitoring (DMS)

A PC monitoring function enables connection to the e-EPOS system, allowing various parameters to be checked during maintenance, such as pump pressures, engine rotation speed, etc. and these can be stored and printed for subsequent analysis.



Convenient Fuse Box

The fuse box is conveniently located in a section of the storage compartment behind the operator's seat providing a clean environment and easy access.



Centralized grease inlets for easy maintenance

The arm grease inlets are grouped for easy access.

DX140LC



TECHNICAL SPECIFICATIONS

DX140LC

* ENGINE

▪ Model

Doosan DLo6
"Common Rail" engine with direct fuel injection and electronic control, 4 valves per cylinder, vertical injectors, water cooled, turbo charged with air to air intercooler. The emission levels are well below the values required for phase III.

▪ Number of cylinders

6

▪ Nominal flywheel power

71 kW(95HP) @ 1,850 rpm (SAE J1349, net)

▪ Max torque

44.5 kgf.m(436 Nm) at 1,400 rpm

▪ Piston displacement

5,890 cc (359 cu.in)

▪ Bore & stroke

∅100 mm x 125 mm (3.9" X 4.9")

▪ Starter

24 V / 4.5 kW

▪ Batteries

2 x 12 V / 100 Ah

▪ Air cleaner

Double element with auto dust evacuation.

* HYDRAULIC SYSTEM

The heart of the system is the e-EPOS (Electronic Power Optimizing System). It allows the efficiency of the system to be optimized for all working conditions and minimizes fuel consumption.

The new e-EPOS is connected to the engine electronic control via a data transfer link to harmonize the operation of the engine and hydraulics.

- The hydraulic system enables independent or combined operations.
- Two travel speeds offer either increased torque or high speed tracking.
- Cross-sensing pump system for fuel savings.
- Auto deceleration system.
- Two operating modes, two power modes.
- Button control of flow in auxiliary equipment circuits.
- Computer-aided pump power control.

▪ Main pumps

2 variable displacement axial piston pumps
max flow: 2 x 114 ℓ /min (2 X 30.1 US gpm, 2 X 25.1 lmp gpm)

▪ Pilot pump

Gear pump - max flow: 27.75 ℓ /min (7.33 US gpm, 6.1 lmp gpm)

▪ Maximum system pressure

Boom/arm/Bucket:
Normal mode: 330 kgf/cm²(324 bar)
Power mode: 350 kgf/cm²(343 bar)
Travel: 330 kgf/cm²(324 bar)
Swing: 245 kgf/cm²(240 bar)

* WEIGHT

Boom 4,600 mm (15'1") ▪ Arm 2,500 mm (8'2") ▪ Bucket SAE 0.51 m³ (0.67 yd³)

Shoe width	Operating weight	Ground pressure (kgf/cm ²)
500 mm (1'8")	13,800 kg (30,423 lb)	0.43 kgf/cm ² (42 kpa, 6.11 psi)
600 mm (2")	14,000 kg (30,864 lb)	0.36 kgf/cm ² (35 kpa, 5.12 psi)
700 mm (2'4")	14,200 kg (31,305 lb)	0.30 kgf/cm ² (29 kpa, 4.26 psi)

■ Weight with Dozer Blade

STD. - Boom 4,600 mm (15'1") ▪ Arm 2,500 mm (8'2") ▪ Bucket SAE 0.51 m³ (0.67 yd³)

Shoe width	Dozer Blade weight	Operating weight
STD. + 500 mm (1'8")	2,500 mm : 590 kg (1,300 lb)	14,770 kg (32,562 lb)
STD. + 600 mm (2")	2,600 mm : 602 kg (1,327 lb)	15,007 kg (33,084 lb)
STD. + 700 mm (2'4")	2,700 mm : 615 kg (1,356 lb)	15,245 kg (33,609 lb)

※ When the dozer blade is installed, additional weight may be occurred by track frame, dozer cylinder, dozer unit, pin assembly, track shoe.

* HYDRAULIC CYLINDERS

The piston rods and cylinder bodies are made of high-strength steel. A shock absorbing mechanism is fitted in all cylinders to ensure shock-free operation and extend piston life.

Cylinders	Quantity	Bore x Rod diameter x stroke
Boom	2	110 X 75 X 1,085mm (4.3" X 3.0" X 3'7")
Arm	1	115 X 80 X 1,108mm (4.5" X 3.1" X 3'8")
Bucket	1	100 X 70 X 900mm (3.9" X 2.8" X 2'11")

* UNDERCARRIAGE

Chassis are of very robust construction, all welded structures are designed to limit stresses.

High-quality material used for durability.

Lateral chassis welded and rigidly attached to the undercarriage. Track rollers lubricated for life, idlers and sprockets fitted with floating seals.

Tracks shoes made of induction-hardened alloy with triple grouser.

Heat-treated connecting pins.

Hydraulic track adjuster with shock-absorbing tension mechanism.

▪ Number of rollers and track shoes per side

Upper rollers: 1

Lower rollers: 7

Shoes: 46

Total length of track: 3,755mm (12'4")

* ENVIRONMENT

Noise levels comply with environmental regulations (dynamic values).

▪ Sound level guarantee

101 dB(A) (2000/14/EC)

▪ Cab sound level

71 dB(A) (ISO 6396)

* SWING MECHANISM

- An axial piston motor with two-stage planetary reduction gear is used for the swing.
- Increased swing torque reduces swing time.
- Internal induction-hardened gear.
- Internal gear and pinion immersed in lubricant bath.
- The swing brake for parking is activated by spring and released hydraulically.

Swing speed: 0 to 10.7 rpm

* DRIVE

Each track is driven by an independent axial piston motor through a planetary reduction gearbox.

Two levers with control pedals guarantee smooth travel with counter-rotation on demand.

▪ Travel speed (fast/slow)

4.7/3.0km/h (2.9/1.9 mph)

▪ Maximum traction force

7,300 / 11,800 kgf (16,094 / 26,014 lbf)

▪ Maximum grade

35° / 70%

* REFILL CAPACITIES

▪ Fuel tank

267 ℓ (70.5 US gal, 58.7 lmp gal)

▪ Cooling system (Radiator capacity)

20 ℓ (5.3 US gal, 4.4 lmp gal)

▪ Engine oil

25 ℓ (6.6 US gal, 5.5 lmp gal)

▪ Swing drive

3.8 ℓ (1.0 US gal, 0.84 lmp gal)

▪ Final drive (each)

3 ℓ (0.8 US gal, 0.66 lmp gal)

▪ Hydraulic system

148 ℓ (39 US gal, 32.6 lmp gal)

▪ Hydraulic tank

99 ℓ (26 US gal, 21.7 lmp gal)

* BUCKET

Capacity		Width		Weight	Recommendation				
PCSA, heaped	CECE heaped	Without side cutters	With side cutters		4,600mm (15'1") One-piece Boom			4,988 mm (16'4") Two-piece Boom	
					2,100mm (6'11") Arm	2,500mm (8'2") Arm	3,000mm (9'10") Arm	2,100 mm (6'11") Arm	2,500 mm (8'2") Arm
0.24m ³ (0.31 yd ³)	0.22m ³	468.4mm (1'6")	534.0mm (1'9")	294 kg (648 lb)	A	A	A	A	A
0.39m ³ (0.51 yd ³)	0.35m ³	736.4mm (2'5")	819.8mm (2'8")	362 kg (798 lb)	A	A	B	A	B
0.45m ³ (0.59 yd ³)	0.40m ³	823.8mm (2'8")	911.0mm (3')	402 kg (886 lb)	A	B	B	B	B
0.51m ³ (0.67 yd ³)	0.45m ³	907.4mm (3')	991.0mm (3'3")	418 kg (922 lb)	A	B	C	B	C
0.59m ³ (0.77 yd ³)	0.51m ³	997.4mm (3'3")	1,081.0mm (3'7")	439 kg (968 lb)	B	C	-	C	-
0.64m ³ (0.84 yd ³)	0.55m ³	1,083.4mm (3'7")	1,167.0mm (3'10")	465 kg (1,025 lb)	C	-	-	C	-

A. Suitable for materials with density of 2,000 kg/m³ (3,370 lb/CU . yd) or less

B. Suitable for materials with density of 1,600 kg/m³ (2,700 lb/CU . yd) or less

C. Suitable for materials with density of 1,100 kg/m³ (1,850 lb/CU . yd) or less

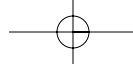

DIMENSIONS

[One-piece Boom]

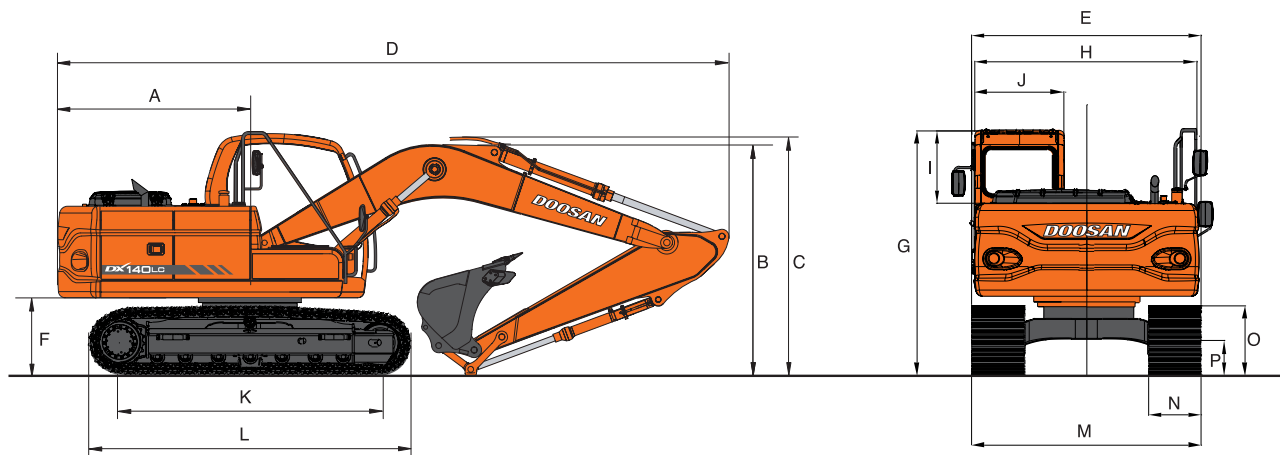

* DIMENSIONS

Boom type (One-piece)		4,600mm(15'1")	
Arm type	2,100mm (6'11")	2,500mm (8'2")	3,000mm (9'10")
Bucket type (PCSA)	0.51m ³	0.51m ³	0.39m ³
A. Tail Swing Radius	→	2,200mm (7'3")	←
B. Shipping Height (Boom)	2,515mm (8'3")	2,630mm (8'8")	3,030mm (9'11")
C. Shipping Height (Hose)	2,570mm (8'5")	2,710mm (8'11")	3,090mm (10'2")
D. Shipping Length	7,690mm (25'3")	7,680mm (25'2")	7,640mm (25'1")
E. Shipping Width	→	2,590mm (8'6")	←
F. C/Weight Clearance	→	894mm (2'11")	←
G. Height Over Cab.	→	2,773mm (9'1")	←
H. House Width	→	2,540mm (8'4")	←
I. Cab. Height above House	→	835mm (2'9")	←
J. Cab. Width	→	960mm (3'2")	←
K. Tumbler Distance	→	3,034mm (9'11")	←
L. Track Length	→	3,755mm (12'4")	←
M. Undercarriage Width	→	2,590mm (8'6")	←
N. Shoe Width	→	600mm (2')	←
O. Track Height	→	728mm (2'5")	←
P. Car Body Clearance	→	410mm (1'4")	←

* DIGGING FORCE

Bucket (PCSA)	0.22m ³	0.35m ³	0.40m ³	0.45m ³	0.51m ³	0.55m ³	0.65m ³
Digging force (ISO)	11,100 kgf	11,100 kgf	11,100 kgf	11,100 kgf	11,100 kgf	11,100 kgf	11,100 kgf
	109 kN	109 kN	109 kN	109 kN	109 kN	109 kN	109 kN
	24,471 lbf	24,471 lbf	24,471 lbf	24,471 lbf	24,471 lbf	24,471 lbf	24,471 lbf
Digging force (SAE)	9,600 kgf	9,600 kgf	9,600 kgf	9,600 kgf	9,600 kgf	9,600 kgf	9,600 kgf
	94 kN	94 kN	94 kN	94 kN	94 kN	94 kN	94 kN
	21,164 lbf	21,164 lbf	21,164 lbf	21,164 lbf	21,164 lbf	21,164 lbf	21,164 lbf

At power boost (ISO)

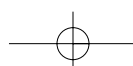

DX140LC

[Two-piece Boom]

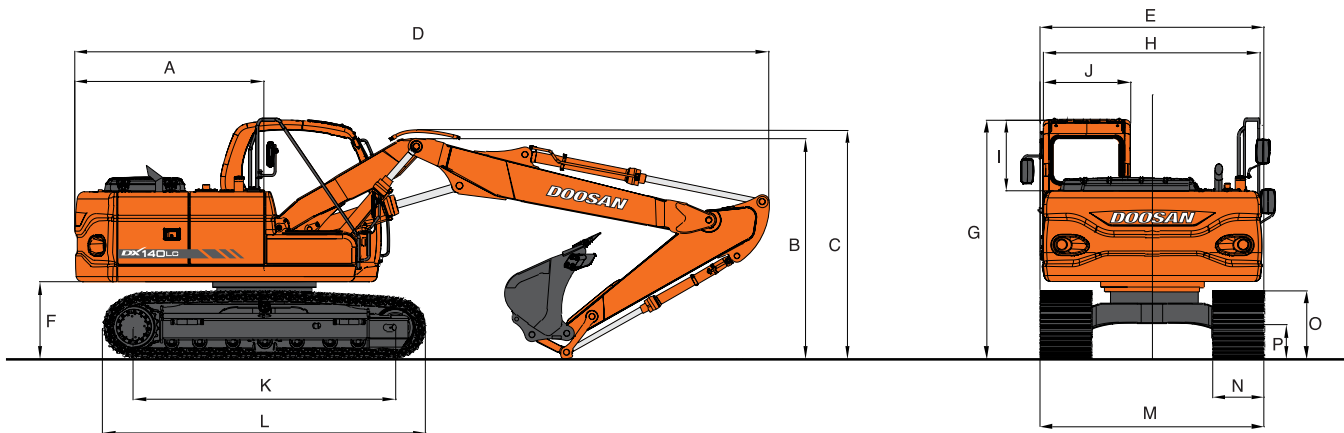

* DIMENSIONS

Boom type (Two-piece)	4,988 mm (16'4")	
Arm type	2,100 mm (6'11")	2,500 mm (8'2")
Bucket type (PCSA)	0.51m ³	0.51m ³
A. Tail Swing Radius	2,200mm (7'3")	+
B. Shipping Height (Boom)	2,555mm (8'6")	2,680mm (8'10")
C. Shipping Height (Hose)	2,655mm (8'9")	2,770mm (9'1")
D. Shipping Length	8,060mm (26'5")	8,015mm (26'4")
E. Shipping Width	2,590mm (8'6")	+
F. C/Weight Clearance	894mm (2'11")	+
G. Height Over Cab.	2,773mm (9'1")	+
H. House Width	2,540mm (8'4")	+
I. Cab. Height above House	835mm (2'9")	+
J. Cab. Width	960mm (3'2")	+
K. Tumbler Distance	3,034mm (9'11")	+
L. Track Length	3,755mm (12'4")	+
M. Undercarriage Width	2,590mm (8'6")	+
N. Shoe Width	600mm (2')	+
O. rack Height	728mm (2'5")	+
P. Car Body Clearance	410mm (1'4")	+

* DIGGING FORCE

Arm	2,100mm	2,500mm	3,000mm
Digging force (ISO)	7,700 kgf	6,500 kgf	6,000 kgf
	75.6 kN	63.8 kN	58.9 kN
	16,975 lbf	14,330 lbf	13,228 lbf
Digging force (SAE)	7,300 kgf	6,300 kgf	5,800 kgf
	71.7 kN	61.8 kN	56.9 kN
	16,094 lbf	13,889 lbf	12,787 lbf

At power boost (ISO)

WORKING RANGES

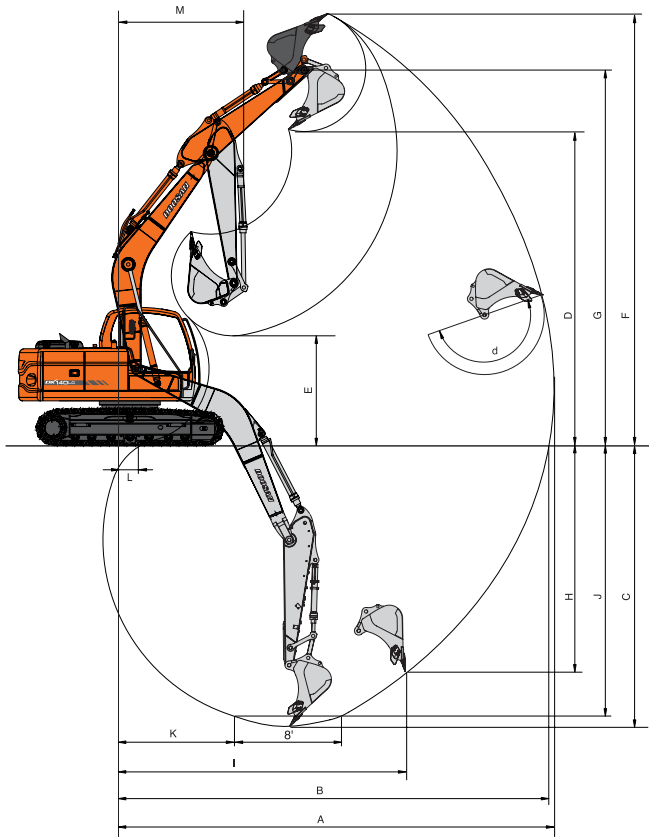

[One-piece Boom]

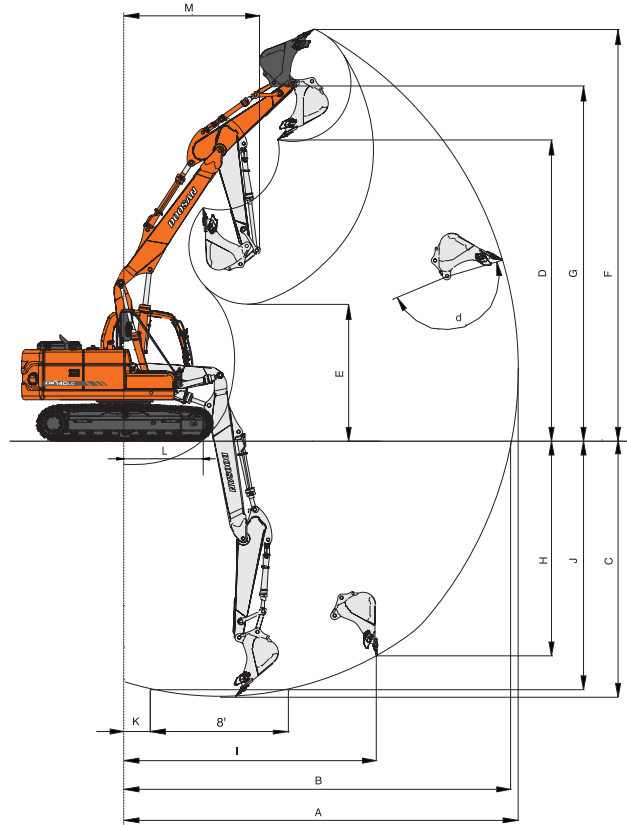

[Two-piece Boom]

* WORKING RANGE

Boom length	4,600mm(15'1") One-piece Boom			4,988mm(16'4") Two-piece Boom	
	2,100mm (6'11")	2,500mm (8'2")	3,000mm (9'10")	2,100mm (6'11")	2,500mm (8'2")
Arm type					
Bucket type (pcsa)	0.51m ³	0.51m ³	0.39m ³	0.51m ³	0.51m ³
A. Max. digging reach	7,845 (25'9")	8,300 (27'3")	8,680 (28'6")	8,380 (27'6")	8,805 (28'11")
B. Max. digging reach at ground level	7,690 (25'3")	8,156 (26'9")	8,540 (28')	8,235 (27')	8,665 (28'5")
C. Max. digging depth	5,250 (17'3")	5,645 (18'6")	6,150 (20'2")	5,440 (17'10")	5,850 (19'2")
D. Max. loading height	5,875 (19'3")	6,300 (20'8")	6,415 (21)	6,420 (21'1")	6,810 (22'4")
E. Min. loading height	2,570 (8'5")	2,170 (7'1")	1,700 (5'7")	2,925 (9'7")	2,935 (9'8")
F. Max. digging height	8,195 (26'11")	8,675 (28'6")	8,745 (28'8")	8,820 (28'11")	9,235 (30'4")
G. Max. bucket pin height	7,110 (23'4")	7,535 (24'9")	7,645 (25'1")	7,650 (25'1")	8,040 (26'5")
H. Max. vertical wall depth	3,810 (12'6")	4,560 (15)	4,830 (15'10")	4,815 (15'10")	5,415 (17'9")
I. Max. radius vertical	5,690 (18'8")	5,555 (18'3")	5,860 (19'3")	5,365 (17'7")	5,270 (17'3")
J. Max. digging depth(8'level)	4,950 (16'3")	5,420 (17'9")	5,920 (19'5")	5,530 (18'2")	5,745 (18'10")
k. Min. radius 8' line	1,850 (6'1")	1,960 (6'5")	1,855 (6'1")	795 (2'7")	800 (2'7")
L. Min. digging reach	1,005 (3'4")	265 (10")	-305 (-1")	2000 (6'7")	1,615 (5'4")
M. Min. swing radius	2,345 (7'8")	2,375 (7'10")	2,585 (8'6")	2,925 (9'7")	2,935 (9'9")
d. Bucket angle (deg)	173°	173°	173°	173°	173°

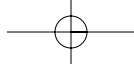

LIFTING CAPACITY

DX140LC

[One-piece Boom]

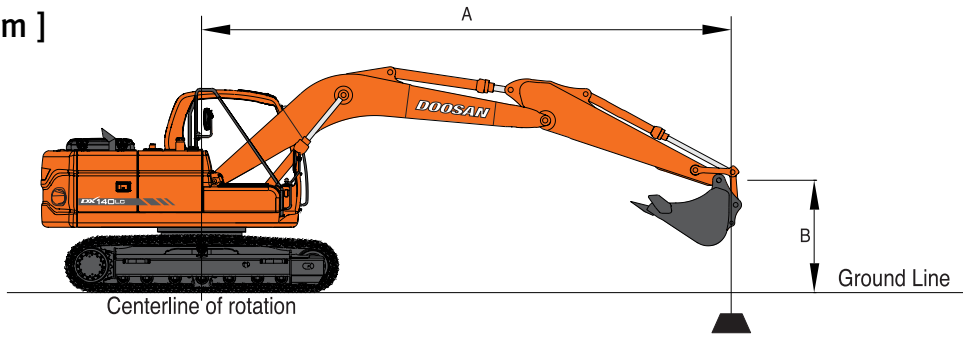

Boom : 4,600mm(15'1") Arm : 2,500mm(8'2") Bucket : SAE 0.51m³(0.67yd³) Shoe : 600mm(2')

Metric

Unit : 1,000kg

A(m)	2		3		4		5		6		Max. Reach		A(m)	
B(m)														
7					*3.73	*3.73						*2.88	*2.88	4.24
6					*3.39	*3.39	*3.59	2.92				*2.45	*2.45	5.32
5					*3.61	*3.61	*3.72	2.94	*2.57	2.11		*2.25	*2.08	6.04
4			*4.25	*4.25	*4.31	4.22	*4.05	2.92	3.42	2.13		*2.17	1.81	6.53
3					*5.38	4.11	*4.61	2.87	3.40	2.11		*2.16	1.66	6.83
2					*6.57	3.99	4.55	2.80	3.37	2.08		*2.20	1.59	6.98
1					6.52	3.88	4.48	2.75	3.33	2.05		*2.29	1.58	6.97
O (Ground)					6.45	3.82	4.44	2.70	3.31	2.03		*2.45	1.64	6.82
-1			*6.07	6.04	6.42	3.79	4.41	2.68	3.30	2.02		*2.71	1.77	6.51
-2	*5.42	*5.42	*9.89	6.08	6.43	3.80	4.42	2.69	3.31	2.03		*3.13	2.03	6.01
-3	*9.35	*9.35	*9.47	6.15	6.47	3.84	4.46	2.72				4.15	2.54	5.24
-4			*7.27	6.27	*5.01	3.94						*4.55	3.74	4.14

Feet

Unit : 1,000lb

A(ft)	10'		15'		20'		Max. Reach		A(ft)	
B(ft)										
25								*7.75	*7.75	10.61
20								*5.46	*5.46	17.17
15			*8.03	7.52				*4.87	4.29	20.58
10			*8.44	7.52	*7.07	4.55		*4.75	3.67	22.38
5			*10.67	7.32	7.30	4.53		*4.92	3.48	22.94
O (Ground)			11.56	7.04	7.20	4.44		*5.41	3.61	22.38
-5			11.33	6.84	7.11	4.35		7.01	4.29	20.14
-10	*17.99	13.00	11.27	6.79	7.09	4.34		9.23	5.66	17.10
-15	*20.42	13.19	11.37	6.88						

Boom : 4,600mm(15'1") Arm : 3,000mm(9'10") Bucket : SAE 0.51m³(0.67yd³) Shoe : 600mm(2')

Metric

Unit : 1,000kg

A(m)	2		3		4		5		6		7		Max. Reach		A(m)	
B(m)																
7																
6							*3.15	2.98						*2.39	*2.39	4.87
5							*3.20	2.98	*3.11	2.16				*2.14	*2.14	5.83
4							*3.63	*3.63	*3.58	2.95	3.45	2.16		*2.00	1.64	6.95
3			*5.78	*5.78	*4.71	4.17	*4.17	2.89	3.42	2.13	2.63	1.61		*2.02	1.51	7.23
2					*5.97	4.03	4.57	2.82	3.38	2.09	2.61	1.60		*2.09	1.45	7.37
1					6.55	3.90	4.49	2.75	3.34	2.05	2.59	1.58		*2.21	1.44	7.37
O (Ground)			*5.04	*5.04	6.45	3.81	4.43	2.70	3.30	2.02	2.57	1.56		*2.39	1.48	7.22
-1			*6.59	6.00	6.40	3.77	4.40	2.66	3.28	2.00				2.61	1.58	6.93
-2	*5.25	*5.25	*9.32	6.01	6.39	3.76	4.39	2.66	3.28	2.00				2.92	1.78	6.47
-3	*8.16	*8.16	*10.17	6.06	6.42	3.79	4.41	2.68						3.50	2.14	5.79
-4	*12.02	*12.02	*8.53	6.16	*6.33	3.85								*4.67	2.91	4.81

Feet

Unit : 1,000lb

A(ft)	10'		15'		20'		Max. Reach		A(ft)	
B(ft)										
25								*5.95	*5.95	13.22
20								*4.76	*4.76	18.87
15			*6.56	*6.56				*4.44	3.85	22.01
10			*7.23	*7.23	*7.22	4.64		*4.45	3.34	23.69
5	*12.34	*12.34	*9.53	7.39	7.35	4.57		*4.71	3.17	24.23
O (Ground)	*11.82	*11.82	11.61	7.08	7.22	4.45		*5.27	3.26	23.70
-5	*17.98	12.88	11.33	6.83	7.10	4.34		7.80	4.78	18.87
-10	*21.95	13.02	11.26	6.77				8.79		13.00
-15	*15.09	13.41								

1. Ratings are based on SAE J1097
2. The load point is a hook located on the back of the bucket.
3. * Rated loads are based on hydraulic capacity.
4. Rated loads do not exceed 87% of hydraulic capacity or 75% of tipping capacity.

: Rating Over Front
 : Rating Over Side or 360 degree

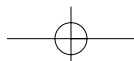

LIFTING CAPACITY

Boom : 4,600mm(15'1") Arm : 2,500mm(8'2") Bucket : SAE 0.51m³(0.67yd³) Shoe : 700mm(2'4")

Metric

Unit : 1,000kg

A(m)	2		3		4		5		6		Max. Reach		A(m)
7					*3.73	*3.73					*2.88	*2.88	4.24
6					*3.39	*3.39	*3.59	2.96			*2.45	*2.45	5.32
5					*3.61	*3.61	*3.72	2.99	*2.57	2.15	*2.25	2.12	6.04
4			*4.25	*4.25	*4.31	4.28	*4.05	2.96	3.48	2.17	*2.17	1.84	6.53
3					*5.38	4.18	*4.61	2.91	3.46	2.15	*2.16	1.69	6.83
2					*6.57	4.05	4.63	2.85	3.43	2.12	*2.20	1.62	6.98
1					6.63	3.94	4.56	2.79	3.39	2.09	*2.29	1.61	6.97
O (Ground)					6.56	3.88	4.51	2.75	3.37	2.06	*2.45	1.67	6.82
-1			*6.07	*6.07	6.53	3.85	4.49	2.73	3.36	2.05	*2.71	1.81	6.51
-2	*5.42	*5.42	*9.89	6.17	6.54	3.86	4.49	2.73	*3.37	2.07	*3.13	2.06	6.01
-3	*9.35	*9.35	*9.47	6.24	6.58	3.90	4.54	2.77			4.22	2.59	5.24
-4			*7.27	6.36	*5.01	4.00					*4.55	3.80	4.14

Feet

Unit : 1,000lb

A(ft)	10'		15'		20'		Max. Reach		A(ft)
25							*7.75	*7.75	10.61
20			*8.03	7.63			*5.46	*5.46	17.17
15			*8.44	7.63	*7.07	4.63	*4.87	4.37	20.58
10			*10.67	7.43	7.43	4.61	*4.75	3.74	22.38
5			11.75	7.15	7.32	4.51	*4.92	3.55	22.94
O (Ground)			11.53	6.96	7.24	4.43	*5.41	3.68	22.38
-5	*17.99	13.20	11.46	6.90	7.22	4.42	7.14	4.37	20.14
-10	*20.42	13.40	11.57	6.99			9.39	5.75	17.10

Boom : 4,600mm(15'1") Arm : 3,000mm(9'10") Bucket : SAE 0.51m³(0.67yd³) Shoe : 700mm(2'4")

Metric

Unit : 1,000kg

A(m)	2		3		4		5		6		7		Max. Reach		A(m)
7													*2.39	*2.39	4.87
6							*3.15	3.02					*2.14	*2.14	5.83
5							*3.20	3.03	*3.11	2.20			*2.04	1.89	6.49
4					*3.63	*3.63	*3.58	3.00	3.51	2.19			*2.00	1.67	6.95
3			*5.78	*5.78	*4.71	4.23	*4.17	2.94	3.48	2.17	2.68	1.64	*2.02	1.54	7.23
2					*5.97	4.09	4.65	2.87	3.44	2.13	2.66	1.63	*2.09	1.48	7.37
1					6.66	3.96	4.57	2.80	3.40	2.09	2.64	1.61	*2.21	1.47	7.37
O (Ground)			*5.04	*5.04	6.56	3.87	4.51	2.74	3.36	2.06	2.62	1.59	*2.39	1.51	7.22
-1			*6.59	6.09	6.50	3.83	4.47	2.71	3.34	2.04			2.66	1.62	6.93
-2	*5.25	*5.25	*9.32	6.11	6.49	3.82	4.46	2.70	3.34	2.04			2.97	1.81	6.47
-3	*8.16	*8.16	*10.17	6.16	6.52	3.85	4.49	2.72					3.56	2.18	5.79
-4	*12.02	*12.02	*8.53	6.26	*6.33	3.91							*4.67	2.96	4.81

Feet

Unit : 1,000lb

A(ft)	10'		15'		20'		Max. Reach		A(ft)
25							*5.95	*5.95	13.22
20			*6.56	*6.56			*4.76	*4.76	18.87
15			*7.23	*7.23	*7.22	4.71	*4.44	3.92	22.01
10	*12.34	*12.34	*9.53	7.51	7.48	4.65	*4.45	3.40	23.69
5			11.80	7.19	7.35	4.53	*4.71	3.23	24.23
O (Ground)	*11.82	*11.82	11.52	6.95	7.23	4.42	*5.27	3.33	23.70
-5	*17.98	13.08	11.40	6.84	7.18	4.37	6.18	3.76	22.01
-10	*21.95	13.22	11.45	6.89			7.95	4.86	18.87
-15	*15.09	13.61					*10.54	8.93	13.00

1. Ratings are based on SAE J1097
2. The load point is a hook located on the back of the bucket.
3. * Rated loads are based on hydraulic capacity.
4. Rated loads do not exceed 87% of hydraulic capacity or 75% of tipping capacity.

: Rating Over Front



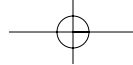









: Rating Over Side or 360 degree



Boom : 4,600mm(15'1") Arm : 2,500mm(8'2") Bucket : SAE 0.51m³(0.67yd³) Shoe : 600mm(2') Dozer blade : 2,590mm(8'6")









Metric

Unit : 1,000kg

A(m)	2		3		4		5		6		Max. Reach		A(m)
													
7					*3.73	*3.73					*2.88	*2.88	4.24
6					*3.39	*3.39	*3.59	3.21			*2.45	*2.45	5.32
5					*3.61	*3.61	*3.72	3.23	*2.57	2.35	*2.25	*2.25	6.04
4			*4.25	*4.25	*4.31	*4.31	*4.05	3.21	3.39	2.36	*2.17	2.02	6.53
3					*5.38	4.51	4.58	3.16	3.37	2.34	*2.16	1.86	6.83
2					*6.57	4.38	4.51	3.10	3.33	2.31	*2.20	1.79	6.98
1					6.46	4.27	4.44	3.04	3.30	2.28	*2.29	1.78	6.97
O (Ground)					6.39	4.21	4.39	3.00	3.27	2.26	*2.45	1.84	6.82
-1			*6.07	*6.07	6.36	4.18	4.37	2.98	3.26	2.25	*2.71	1.98	6.51
-2	*5.42	*5.42	*9.89	6.67	6.37	4.19	4.37	2.98	3.28	2.27	*3.13	2.26	6.01
-3	*9.35	*9.35	*9.47	6.74	6.41	4.23	4.42	3.01			4.11	2.82	5.24
-4			*7.27	6.86	*5.01	4.33					*4.55	4.11	4.14

Feet















Unit : 1,000lb

A(ft)	10'		15'		20'		Max. Reach		A(ft)	
										
25								*7.75	*7.75	10.61
20			*8.03	*8.03				*5.46	*5.46	17.17
15			*8.44	8.24	*7.07	5.05		*4.87	4.78	20.58
10			*10.67	8.04	7.23	5.03		*4.75	4.11	22.38
5			11.45	7.76	7.12	4.94		*4.92	3.91	22.94
O (Ground)			11.22	7.57	7.03	4.86		*5.41	4.05	22.38
-5	*17.99	14.28	11.16	7.51	7.02	4.85		6.94	4.80	20.14
-10	*20.42	14.48	11.26	7.60				9.14	6.27	17.10

Boom : 4,600mm(15'1") Arm : 3,000mm(9'10") Bucket : SAE 0.51m³(0.67yd³) Shoe : 600mm(2') Dozer blade : 2,590mm(8'6")









Metric

Unit : 1,000kg

A(m)	2		3		4		5		6		7		Max. Reach		A(m)	
																
7														*2.39	*2.39	4.87
6							*3.15	*3.15						*2.14	*2.14	5.83
5							*3.20	*3.20	*3.11	2.40				*2.04	*2.04	6.49
4					*3.63	*3.63	*3.58	3.24	3.42	2.39				*2.00	1.83	6.95
3			*5.78	*5.78	*4.71	4.56	*4.17	3.19	3.39	2.36	2.60	1.81		*2.02	1.70	7.23
2					*5.97	4.42	4.53	3.11	3.35	2.33	2.58	1.79		*2.09	1.63	7.37
1					6.49	4.29	4.45	3.04	3.30	2.29	2.56	1.77		*2.21	1.62	7.37
O (Ground)			*5.04	*5.04	6.39	4.21	4.39	2.99	3.27	2.25	2.55	1.76		*2.39	1.67	7.22
-1			*6.59	*6.59	6.34	4.16	4.35	2.96	3.25	2.23				2.58	1.78	6.93
-2	*5.25	*5.25	*9.32	6.61	6.33	4.15	4.34	2.95	3.25	2.23				2.89	1.99	6.47
-3	*8.16	*8.16	*10.17	6.66	6.36	4.18	4.37	2.97						3.47	2.39	5.79
-4	*12.02	*12.02	*8.53	6.76	*6.33	4.24								*4.67	3.21	4.81

Feet

Unit : 1,000lb

A(ft)	10'		15'		20'		Max. Reach		A(ft)	
										
25								*5.95	*5.95	13.22
20			*6.56	*6.56				*4.76	*4.76	18.87
15			*7.23	*7.23	*7.22	5.14		*4.44	4.30	22.01
10	*12.34	*12.34	*9.53	8.12	7.28	5.08		*4.45	3.75	23.69
5			11.50	7.81	7.14	4.95		*4.71	3.57	24.23
O (Ground)	*11.82	*11.82	11.22	7.56	7.03	4.85		*5.27	3.68	23.70
-5	*17.98	14.17	11.10	7.46	6.97	4.80		6.00	4.14	22.01
-10	*21.95	14.30	11.15	7.50				7.73	5.32	18.87
-15	*15.09	14.70						*10.54	9.67	13.00

1. Ratings are based on SAE J1097
2. The load point is a hook located on the back of the bucket.
3. * Rated loads are based on hydraulic capacity.
4. Rated loads do not exceed 87% of hydraulic capacity or 75% of tipping capacity.

 : Rating Over Front

 : Rating Over Side or 360 degree

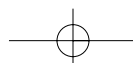

DX140LC

[Two-piece Boom]

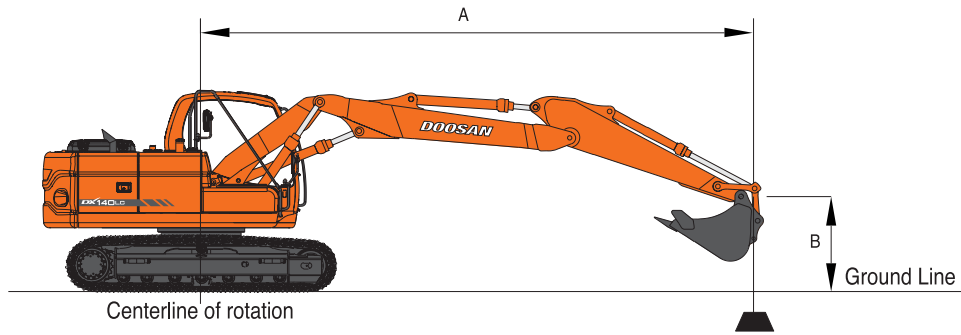

Boom : 4,988mm(16'4") Arm : 2,500mm(9'10") Bucket : SAE 0.51m³(0.67yd³) Shoe : 700mm(2'4")

Metric

Unit : 1,000kg

A(m) \ B(m)	3		4		5		6		7		Max. Reach		A(m)
7											*3.24	3.20	4.75
6					*2.79	*2.79					*3.03	2.31	5.73
5			*2.74	*2.74	*2.89	*2.89	*3.11	2.17			*2.84	1.89	6.41
4	*4.04	*4.04	*3.54	*3.54	*3.31	2.96	*3.25	2.16			2.74	1.65	6.87
3			*4.69	4.13	*3.94	2.88	3.46	2.12	2.65	1.59	2.54	1.52	7.16
2			*5.94	3.96	4.61	2.79	3.41	2.08	2.63	1.58	2.44	1.45	7.30
1			6.55	3.83	4.52	2.72	3.36	2.03	2.61	1.56	2.43	1.44	7.29
O (Ground)			6.46	3.75	4.46	2.66	3.33	2.00	2.59	1.54	2.51	1.49	7.15
-1	*3.46	*3.46	6.43	3.73	4.43	2.64	3.31	1.98			2.68	1.60	6.85
-2	*6.65	5.99	6.45	3.74	4.43	2.64	3.32	1.99			3.02	1.81	6.38
-3			6.50	3.78	4.47	2.67					4.04	2.43	5.32

Feet

Unit : 1,000lb

A(ft) \ B(ft)	10'		15'		20'		Max. Reach		A(ft)
25							*7.21	*7.21	12.76
20			*5.77	*5.77			*6.75	5.22	18.55
15			*6.67	*6.67	*6.95	4.64	*6.15	3.91	21.74
10			*9.15	7.36	7.43	4.55	5.61	3.36	23.45
5			11.65	6.98	7.28	4.41	5.35	3.18	23.99
O (Ground)			11.37	6.74	7.15	4.29	5.53	3.28	23.45
-5	*11.46	*11.46	11.30	6.67	7.11	4.26	6.25	3.74	21.75
-10			11.41	6.77			9.28	5.57	17.04

1. Ratings are based on SAE J1097
2. The load point is a hook located on the back of the bucket.
3. * Rated loads are based on hydraulic capacity.
4. Rated loads do not exceed 87% of hydraulic capacity or 75% of tipping capacity.

: Rating Over Front
 : Rating Over Side or 360 degree

STANDARD AND OPTIONAL EQUIPMENT

* STANDARD EQUIPMENT

▪ Hydraulic system

- Boom and arm flow regeneration
- Boom and arm holding valves
- Swing anti-rebound valves
- Spare ports(valve)
- One-touch power boost

▪ Cabin & Interior

- Viscous cab mounts
- All weather sound suppressed type cab
- Air conditioner
- Adjustable suspension seat with head rest and adjustable arm rest
- Pull-up type front window and removable lower front window
- Room light
- Intermittent windshield wiper
- Cigarette lighter and ashtray
- Cup holder
- Hot & Cool box
- LCD color monitor panel
- Engine speed(RPM) control dial
- AM/FM radio
- Remote radio ON/OFF switch
- 12V spare powers socket
- Serial communication port for laptop PC interface
- Joystick lever with 3 switches
- Sunvisor
- Sun roof
- Wiper

▪ Safety

- Large handrails and step
- Punched metal anti-slip plates
- Seat belt
- Hydraulic safety lock lever
- Safety glass
- Hammer for emergency escape
- Right and left rearview mirrors
- Travel alarm
- Emergency engine stop

▪ Undercarriage

- Hydraulic track adjuster
- Track guards
- Greased and sealed track link

▪ Others

- Double element air cleaner
- Fuel pre-filter
- Dust screen for radiator/oil cooler
- Engine overheat prevention system
- Engine restart prevention system
- Self-diagnostic system
- Alternator(24V, 60 amps)
- Electric horn
- Halogen working lights(frame mounted 2, boom mounted 2)

* OPTIONAL EQUIPMENT

Some of these optional equipment may be standard in some markets. Some of these optional equipment cannot be available on some markets. You must check with the local DOOSAN dealer to know about the availability or to release the adaptation following the needs of the applications.

▪ Safety

- Boom and arm hose rupture protection valve
- Overload warning device
- Cabin Top/Front guard(ISO 10262, FOGS standard)
- Travel & swing alarm
- Rotation beacon
- Lamp on counter weight

▪ Cabin & Interior

- Air suspension seat
- MP3/CD player or cassette player
- Rain shield
- 2 front lamps
- 4 front + 2 rear lamps

▪ Undercarriage

- 500mm/600mm/700mm shoe
- 2,490mm/2,590mm/2,690mm dozer blade

▪ Others

- Piping for crusher
- Piping for quick clamp
- Breaker filter
- Lower wiper
- Fuel heater
- Fuel filler pump